

MDR Brushless DC Motor standard type PM486FE Roller diameter $\phi 48.6$

Roller diameter $\phi 48.6$ PM486FE

- Roller diameter / $\phi 48.6$
- Thickness / t1.4
- Voltage / 24V DC
- Tube material / STKM12
- Surface treatment / Trivalent chromate processing

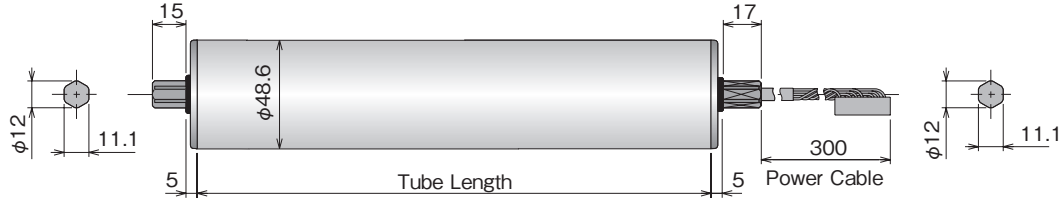

Tube Length : PM486FE

	290mm	≥ 290 mm						
Tube Length (mm)	300	400	500	600	700	800	900	1000
Weight (kg)	2.4	2.5	2.7	2.8	3.0	3.1	3.3	3.4
Spring loaded shaft	<input type="checkbox"/>	<input type="checkbox"/>	<input type="checkbox"/>	<input type="checkbox"/>	<input type="checkbox"/>	<input type="checkbox"/>	<input type="checkbox"/>	<input type="checkbox"/>

- Conveyor frame inside dimension and frame hole shape vary by the manufacturer.
- A gap of 2~5mm is required between the frame inside dimension and Power Moller.

Product Designation :

PM486FE - 17 - 400 - D - 024 - **BR**

Power Moller model Nominal Speed Tube Length Voltage Options

- Motor type : FE
- Nominal Speed : 17,60,90
- Tube Length : Specify in mm.
- Voltage : D-024 (24VDC)
- Options : Each of the following optional specification may be selected.

Mounting Bracket : No.MBB-081

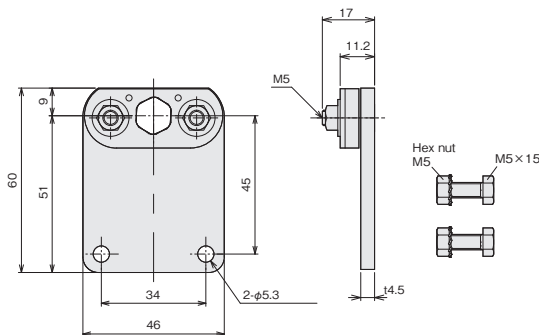

- *Attach to the power cable side.
- Apply 6~10Nm torque for securing the Power Moller mounting shaft, and 3.5Nm for securing the bracket.

Options : PM486FE

Rubber Laggings - NR, UR, NB, CR
Natural rubber, Urethane, NBR, Neoprene

BR Built-In Brake - BR ^{*1}
 360mm ≥ 360 mm

DR Drip Proof ^{*2}
 300mm ≥ 300 mm

WA Water Proof ^{*2}
 310mm ≥ 310 mm

VG Poly V-Belt Pulley
 290mm ≥ 290 mm

VP V-Belt Pulley
 300mm ≥ 300 mm

P2 Double Grooved Tube ^{*3}
 340mm ≥ 340 mm

JD

Both-end D-shaped shaft

*1 When holding type built-in brake is required, specify along with a driver card compatible with such brake specification.

[Electric brake (without holding function) is equipped as a standard specification.]
Nominal speed 90m/min rollers are not applicable.

*2 Manufacturability and tube length are different depending on the specification combination, contact our sales support.

(A standard mounting bracket is No. MBD-081-D.)

*3 Up to 800mm can be produced.

 [MDR Selection Tool] is available on our web page.

Operating characteristics with CB-016 driver card

PM486FE-17

Speed (m/min)	Tangential Force (N)		Input Current (A)		Power Input (W)	Power Output (W)	Internal Rotary Switch No.		External input voltage (V)
	No-load	Rated	No-load	Starting			SW1#5	SW5	
16.9	150		0.8		50	83	9	9.6~9.9	344
15.5	150		0.7		50	83	8	9.1~9.4	
14.8	150		0.7		50	83	7	8.6~8.9	
14.1	150		0.6		50	83	6	8.1~8.4	
13.4	150		0.6		50	83	5	7.6~7.9	
12.7	153		0.6		47	82	4	7.1~7.4	
11.2	160		0.5		45	79	3	6.6~6.9	
10.5	163		0.5		42	76	2	6.1~6.4	
9.8	166		0.5		39	73	1	5.6~5.9	
9.1	169		0.5		37	71	0	5.1~5.4	
8.4	172		0.4		36	71	9	4.6~4.9	
7.7	175		0.4		33	70	8	4.1~4.4	
7.0	178		0.4		30	66	7	3.6~3.9	
6.3	181		0.4		28	61	6	3.1~3.4	
5.6	185		0.3		24	61	5	2.6~2.9	
4.9	188		0.3		23	60	4	2.1~2.4	
4.2	191		0.3		20	54	3	1.6~1.9	
3.5	194		0.2		16	53	2	1.1~1.4	
2.8	197		0.2		13	50	1	0.6~0.9	
2.1	200		0.2		11	47	0	0.1~0.4	

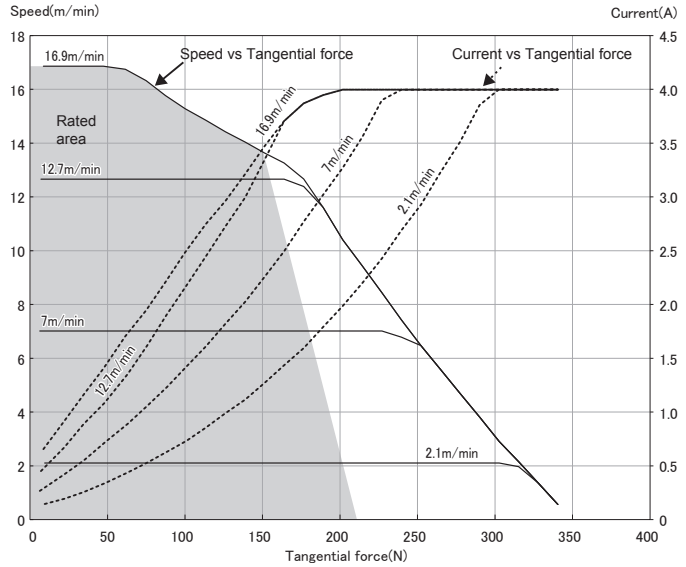

PM486FE-60

Speed (m/min)	Tangential Force (N)		Input Current (A)		Power Input (W)	Power Output (W)	Internal Rotary Switch No.		External input voltage (V)
	No-load	Rated	No-load	Starting			SW1#5	SW5	
60.0	48		0.8		50	83	9	9.6~9.9	110
55.0	48		0.7		50	83	8	9.1~9.4	
52.5	48		0.7		50	83	7	8.6~8.9	
50.0	48		0.6		50	83	6	8.1~8.4	
47.5	48		0.6		50	83	5	7.6~7.9	
45.0	49		0.6		47	82	4	7.1~7.4	
40.0	51		0.5		45	79	3	6.6~6.9	
37.5	52		0.5		42	76	2	6.1~6.4	
35.0	53		0.5		39	73	1	5.6~5.9	
32.5	54		0.5		37	71	0	5.1~5.4	
30.0	55		0.4		36	71	9	4.6~4.9	
27.5	56		0.4		33	70	8	4.1~4.4	
25.0	57		0.4		30	66	7	3.6~3.9	
22.5	58		0.4		28	61	6	3.1~3.4	
20.0	59		0.3		24	61	5	2.6~2.9	
17.5	60		0.3		23	60	4	2.1~2.4	
15.0	61		0.3		20	54	3	1.6~1.9	
12.5	62		0.2		16	53	2	1.1~1.4	
10.0	63		0.2		13	50	1	0.6~0.9	
7.5	64		0.2		11	47	0	0.1~0.4	

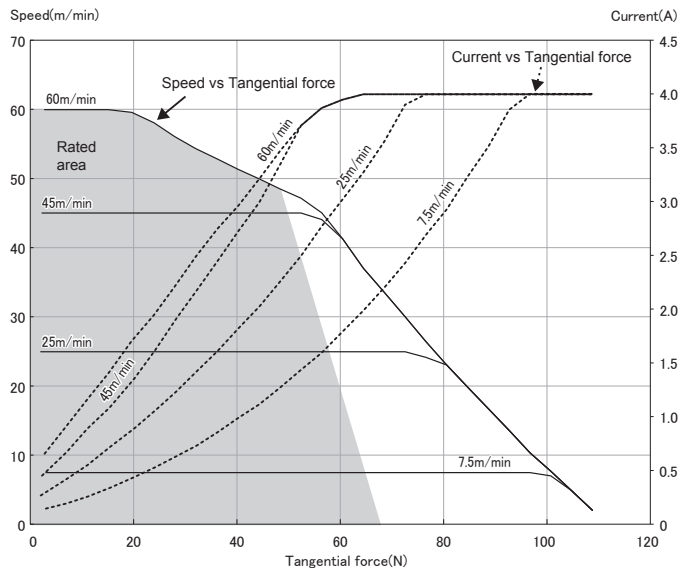

PM486FE-90

Speed (m/min)	Tangential Force (N)		Input Current (A)		Power Input (W)	Power Output (W)	Internal Rotary Switch No.		External input voltage (V)
	No-load	Rated	No-load	Starting			SW1#5	SW5	
101.2	32		0.8		50	83	9	9.6~9.9	74
92.7	32		0.7		50	83	8	9.1~9.4	
88.5	32		0.7		50	83	7	8.6~8.9	
84.3	32		0.6		50	83	6	8.1~8.4	
80.1	32		0.6		50	83	5	7.6~7.9	
75.9	33		0.6		47	82	4	7.1~7.4	
67.4	34		0.5		45	79	3	6.6~6.9	
63.2	35		0.5		42	76	2	6.1~6.4	
59.0	36		0.5		39	73	1	5.6~5.9	
54.8	36		0.5		37	71	0	5.1~5.4	
50.6	37		0.4		36	71	9	4.6~4.9	
46.4	38		0.4		33	70	8	4.1~4.4	
42.1	38		0.4		30	66	7	3.6~3.9	
37.9	39		0.4		28	61	6	3.1~3.4	
33.7	40		0.3		24	61	5	2.6~2.9	
29.5	40		0.3		23	60	4	2.1~2.4	
25.3	41		0.3		20	54	3	1.6~1.9	
21.1	42		0.2		16	53	2	1.1~1.4	
16.9	42		0.2		13	50	1	0.6~0.9	
12.6	43		0.2		11	47	0	0.1~0.4	

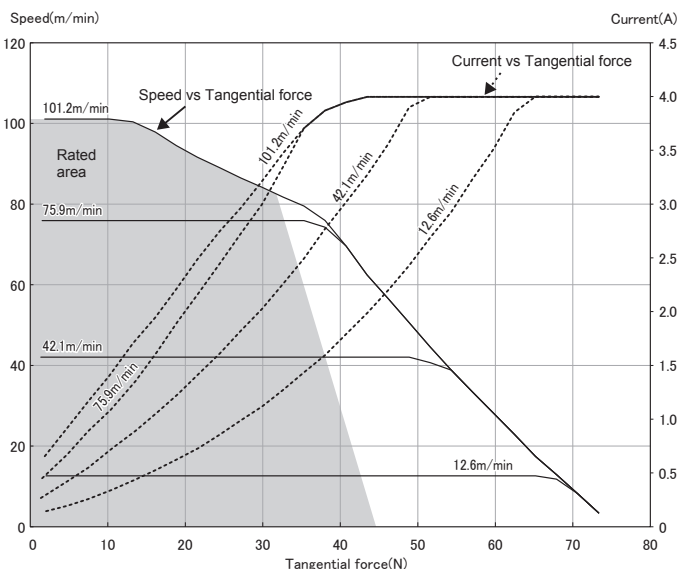

* The values in the characteristics list are when an ambient temperature is 25 degree C, and only for your reference and not the warranted values. The values represent the characteristics of a single standard motor roller (no linked operation) without including other specifications, and the values may change when including other specifications or with linked operation.

 [MDR Selection Tool] is available on our web page.

Operating characteristics with HB-510 driver card

PM486FE-17

Speed (m/min)	Tangential Force (N)		Input Current (A)		Power Input (W)	Power Output (W)	Rotary SW No	External input voltage (V)
	No-load	Rated	No-load	Starting				
16.9	150		0.8		50	83	9	9.3~9.7
15.5	150		0.7		50	83	8	8.3~8.7
14.1	150		0.6		50	83	7	7.3~7.7
12.7	153		0.6		47	82	6	6.3~6.7
11.2	160		0.5		45	79	5	5.3~5.7
9.8	166		0.5		39	73	4	4.3~4.7
8.4	172		0.4		36	71	3	3.3~3.7
7.0	178		0.4		30	66	2	2.3~2.7
5.6	185		0.3		24	61	1	1.3~1.7
4.2	191		0.3		20	54	0	0.3~0.7

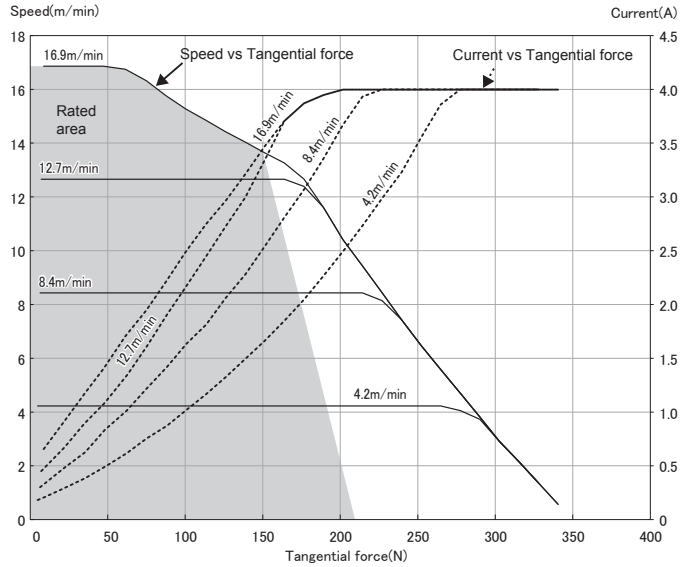

PM486FE-60

Speed (m/min)	Tangential Force (N)		Input Current (A)		Power Input (W)	Power Output (W)	Rotary SW No	External input voltage (V)
	No-load	Rated	No-load	Starting				
60.0	48		0.8		50	83	9	9.3~9.7
55.0	48		0.7		50	83	8	8.3~8.7
50.0	48		0.6		50	83	7	7.3~7.7
45.0	49		0.6		47	82	6	6.3~6.7
40.0	51		0.5		45	79	5	5.3~5.7
35.0	53		0.5		39	73	4	4.3~4.7
30.0	55		0.4		36	71	3	3.3~3.7
25.0	57		0.4		30	66	2	2.3~2.7
20.0	59		0.3		24	61	1	1.3~1.7
15.0	61		0.3		20	54	0	0.3~0.7

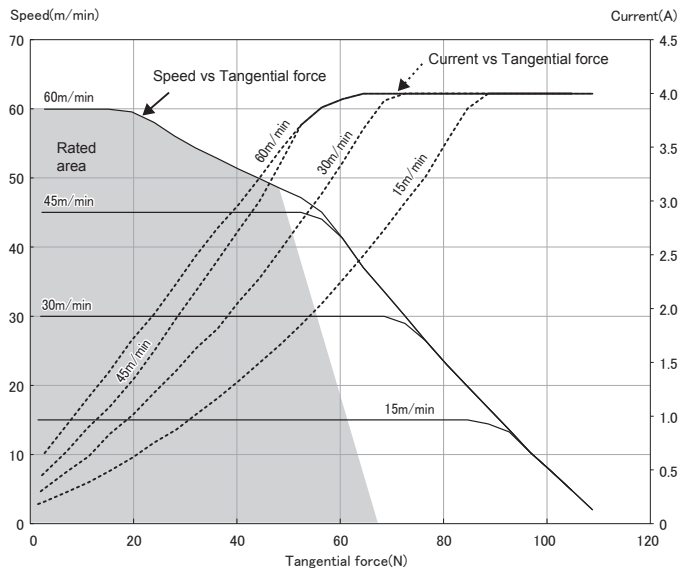

PM486FE-90

Speed (m/min)	Tangential Force (N)		Input Current (A)		Power Input (W)	Power Output (W)	Rotary SW No	External input voltage (V)
	No-load	Rated	No-load	Starting				
101.2	32		0.8		50	83	9	9.3~9.7
92.7	32		0.7		50	83	8	8.3~8.7
84.3	32		0.6		50	83	7	7.3~7.7
75.9	33		0.6		47	82	6	6.3~6.7
67.4	34		0.5		45	79	5	5.3~5.7
59.0	36		0.5		39	73	4	4.3~4.7
50.6	37		0.4		36	71	3	3.3~3.7
42.1	38		0.4		30	66	2	2.3~2.7
33.7	40		0.3		24	61	1	1.3~1.7
25.3	41		0.3		20	54	0	0.3~0.7

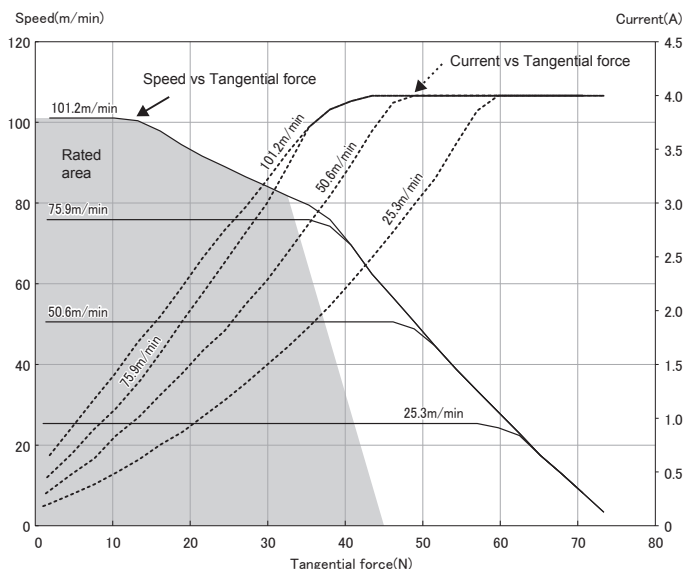

 [MDR Selection Tool] is available on our web page.

Operating characteristics with HBM-604/IB-C02 driver card

PM486FE-17

Speed (m/min)	Tangential Force (N)		Input Current (A)		Power Input (W)	Power Output (W)	Rotary SW No
	Rated	Starting	No-load	Starting			
16.9	116		0.6		41	66	9
15.5	116		0.5		41	65	8
14.1	116		0.5		39	64	7
12.7	119		0.4		35	58	6
11.2	119		0.4		31	53	5
9.8	119		0.4		27	49	4
8.4	122		0.3		23	43	3
7.0	122		0.3		20	38	2
5.6	122		0.2		17	37	1
4.2	125		0.2		13	32	0

* Internal speed SW3/4 is for HBM-604.

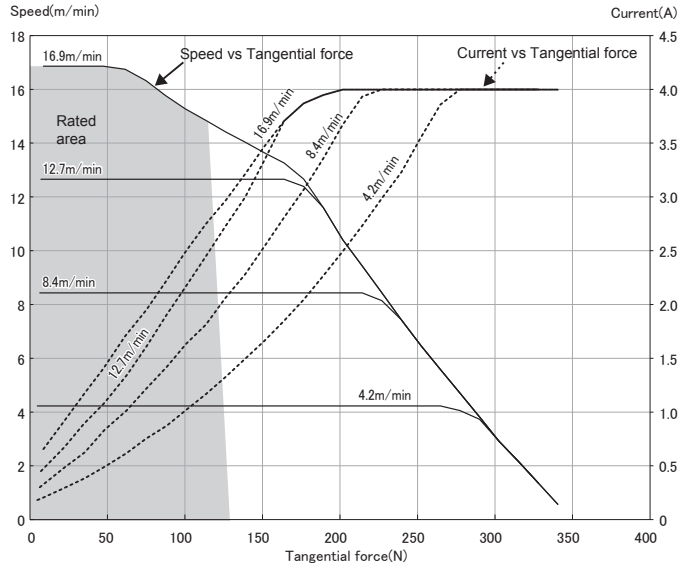

PM486FE-60

Speed (m/min)	Tangential Force (N)		Input Current (A)		Power Input (W)	Power Output (W)	Rotary SW No
	Rated	Starting	No-load	Starting			
60.0	37		0.6		41	66	9
55.0	37		0.5		41	65	8
50.0	37		0.5		39	64	7
45.0	38		0.4		35	58	6
40.0	38		0.4		31	53	5
35.0	38		0.4		27	49	4
30.0	39		0.3		23	43	3
25.0	39		0.3		20	38	2
20.0	39		0.2		17	37	1
15.0	40		0.2		13	32	0

* Internal speed SW3/4 is for HBM-604.

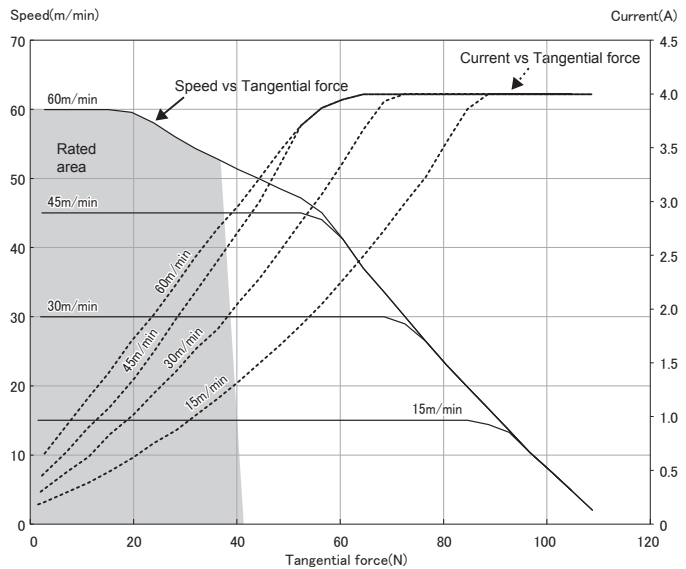

PM486FE-90

Speed (m/min)	Tangential Force (N)		Input Current (A)		Power Input (W)	Power Output (W)	Rotary SW No
	Rated	Starting	No-load	Starting			
101.2	25		0.6		41	66	9
92.7	25		0.5		41	65	8
84.3	25		0.5		39	64	7
75.9	26		0.4		35	58	6
67.4	26		0.4		31	53	5
59.0	26		0.4		27	49	4
50.6	26		0.3		23	43	3
42.1	26		0.3		20	38	2
33.7	26		0.2		17	37	1
25.3	27		0.2		13	32	0

* Internal speed SW3/4 is for HBM-604.

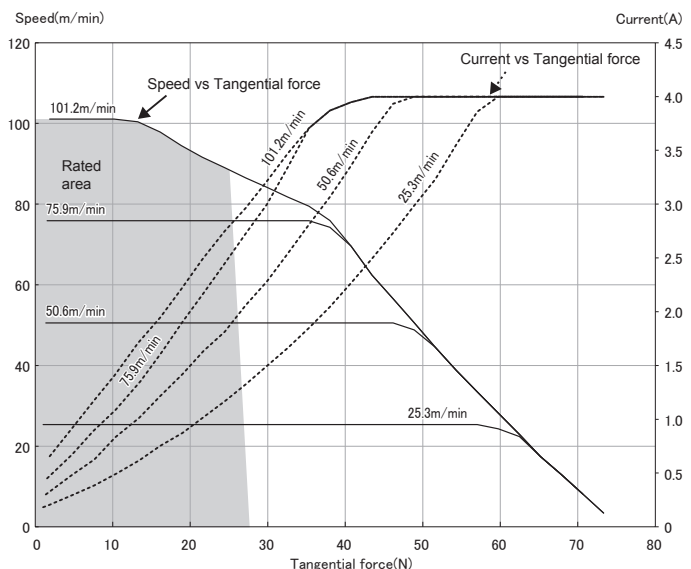

 [MDR Selection Tool] is available on our web page.

Operating characteristics with IB-E03 driver card

PM486FE-17

Speed (m/min)	Tangential Force (N)		Input Current (A)		Power Input (W)	Power Output (W)
	No-load	Rated	No-load	Starting		
16.9	116		0.6		41	66
15.5	116		0.5		41	66
14.8	116		0.5		41	66
14.1	116		0.5		40	65
13.4	119		0.5		39	64
12.7	119		0.4		37	62
11.2	119		0.4		34	60
10.5	119		0.4		32	57
9.8	122		0.4		30	54
9.1	122		0.4		28	51
8.4	122		0.3		26	49
7.0	122		0.3		20	38
5.6	125		0.2		17	37
4.2	125		0.2		13	32
2.8	125		0.2		9	27
2.1	125		0.2		7	24

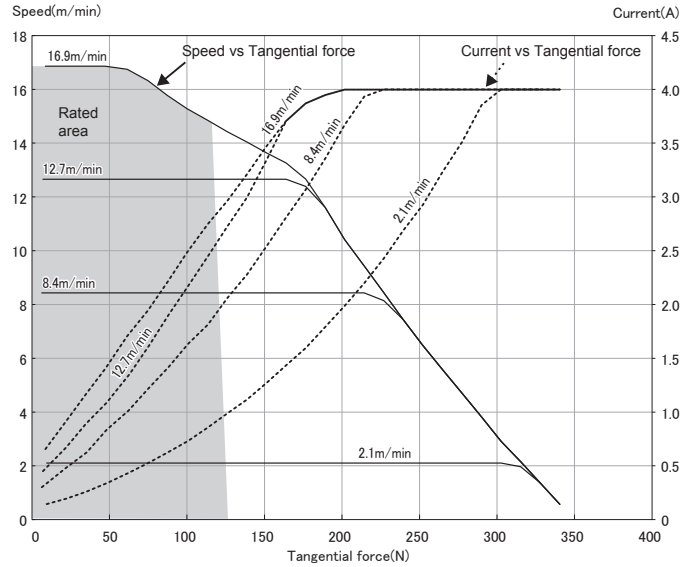

PM486FE-60

Speed (m/min)	Tangential Force (N)		Input Current (A)		Power Input (W)	Power Output (W)
	No-load	Rated	No-load	Starting		
60.0	37		0.6		41	66
55.0	37		0.5		41	66
52.5	37		0.5		41	66
50.0	37		0.5		40	65
47.5	38		0.5		39	64
45.0	38		0.4		37	62
40.0	38		0.4		34	60
37.5	38		0.4		32	57
35.0	39		0.4		30	54
32.5	39		0.4		28	51
30.0	39		0.3		26	49
25.0	39		0.3		20	38
20.0	40		0.2		17	37
15.0	40		0.2		13	32
10.0	40		0.2		9	27
7.5	40		0.2		7	24

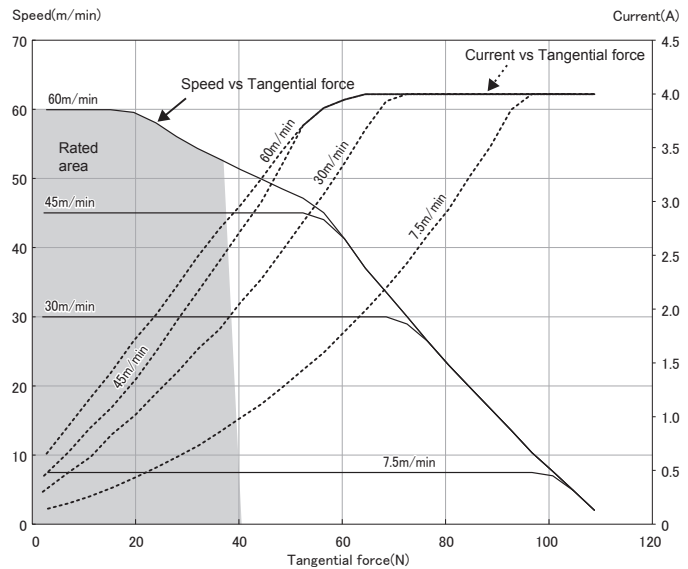

PM486FE-90

Speed (m/min)	Tangential Force (N)		Input Current (A)		Power Input (W)	Power Output (W)
	No-load	Rated	No-load	Starting		
101.2	25		0.6		41	66
92.7	25		0.5		41	66
88.5	25		0.5		41	66
84.3	25		0.5		40	65
80.1	26		0.5		39	64
75.9	26		0.4		37	62
67.4	26		0.4		34	60
63.2	26		0.4		32	57
59.0	26		0.4		30	54
54.8	26		0.4		28	51
50.6	26		0.3		26	49
42.1	26		0.3		20	38
33.7	27		0.2		17	37
25.3	27		0.2		13	32
16.9	27		0.2		9	27
12.6	27		0.2		7	24

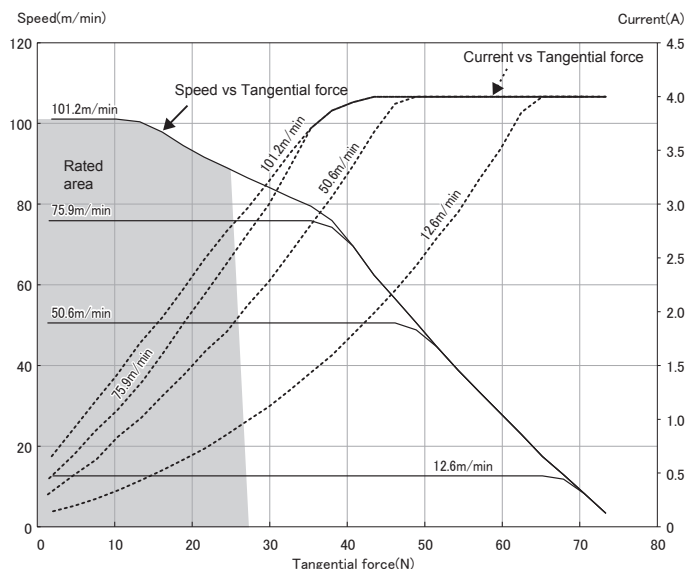

* The values in the characteristics list are when an ambient temperature is 25 degree C, and only for your reference and not the warranted values. The values represent the characteristics of a single standard motor roller (no linked operation) without including other specifications, and the values may change when including other specifications or with linked operation.