

Driver Card

ZPA Hybrid driver card HB-510

RoHS
Conformity

CE
Conformity



[Applicable MDR models]

PM486FE · PM500FE
PM486FP · PM500FP
PM570FE · PM605FE · PMT42FE

[Driver model]

HB-510N / LT

N : For standard motor
NPN signal input and output
P : For standard motor PNP signal input and output
BN : For built-in brake motor NPN signal input and output
BP : For built-in brake motor PNP signal input and output

LT : Low temp



HB 510 series hybrid board can not be used in conjunction with HB 508 series card.
All the cards connected though communication cable should be the same and identical.
If different HB cards are used, they should form separate line, and control between different HB card lines should be made with PLC or other equivalent equipment.

Standard Accessories

- Power connector (CN 1) _____ 1pce
- Sensor connector (CN 1) _____ 1pce
- Screw M4×15 _____ 4pcs
- Nut M4 _____ 4pcs

Option

- Communication cable (CAHB05-length[mm]) _____ 1pce
- Control connector(PAHB08:CN2) _____ 1pce

■ Built-in *ZPA logic for avoiding collisions between transferred loads

Multiple drive powers loaded on a single line enables control by zone. Transfer condition before and after the own zone is judged for moving or stopping. Driving only the required zone saves energy and reduces noise.
*Zero Pressure Accumulation

■ Speed change is enabled in each zone

- Distributed drive control can set a variety of speed in a single line.
- Enables flexible transfer to meet the purpose such as high speed between processes and low speed in a process.
- Digital setting for easy speed adjustment.
- Enables speed change of the entire line at once.

■ Built-in stable speed function

- Enables stable-speed transfer regardless of load changes.
- This helps improve transfer accuracy.

■ Intelligent timers for avoiding line troubles

- Generating an error signal for stopping at load congestion (JAM timer).
- Driving for a set time after sensor OFF in the own zone (RUN hold timer).
- Driving for a set time after the upstream sensor OFF and stop if not carried in (Sensor timer)

■ Error identification by LED

- LED indication of thermal error / lock error / JAM error.

[ZPA Motion]

The driver card contains two types of logic for enabling ZPA transfer only by connecting Power Moller and sensor to the driver card (Driver cards are mutually connected by communication cable). No programming of PLC or complex wiring is necessary.

● Sequential starting Singulated release mode

After checking the empty condition of the downstream zone, the own zone starts to move.

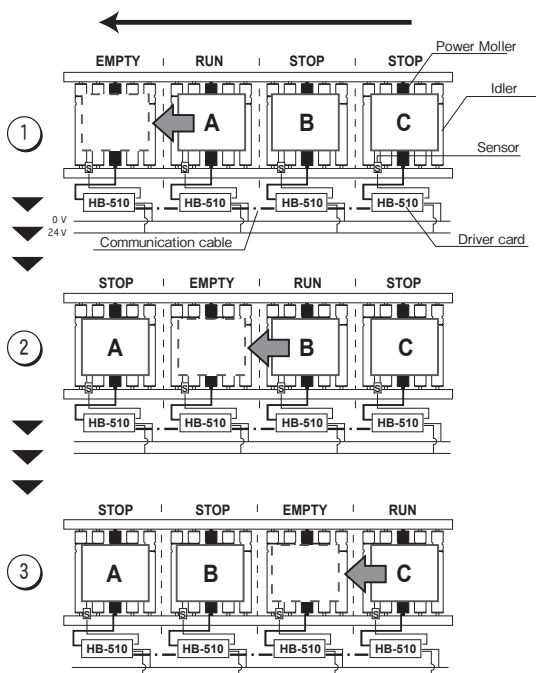

● Simultaneous starting Slug release mode

After checking the empty condition of the downstream zone, all zones containing a load start to move.

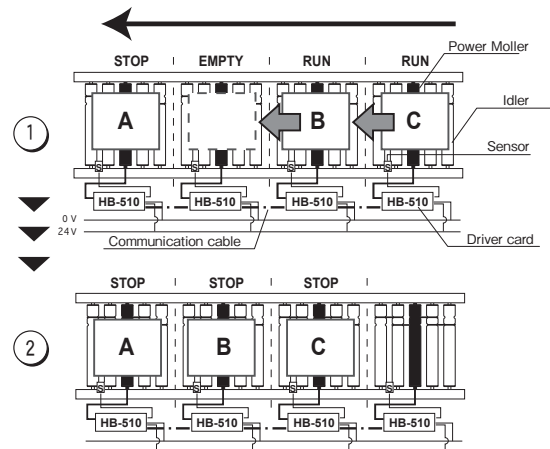

R U N : Own zone moves to feed the load to the downstream.
S T O P : A load remains in the own zone.
E M P T Y : Own zone is empty and ready to receive a load.

[Run-on-Demand Function]

- Only the zone requiring transfer can be driven (Standard function not requiring setting).
- Energy-efficient and low noise because the entire line is not needed for operation.

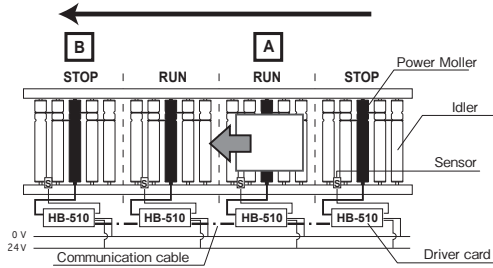

- Zone [B] is stopped because no load exists in the upstream zone (sensor OFF).

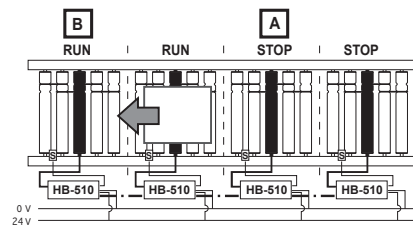

- Zone [B] runs because a load exists in the upstream zone (sensor ON).
- Zone [A] stops after completing the load transfer.

[Auto-Reset Function]

- When power is supplied or after cancelling emergency stop, and the own zone sensor is not ON, then it moves at the lowest speed after the time set on sensor timer.
- This function is effective when a load is stopped between sensors when the power is supplied again.

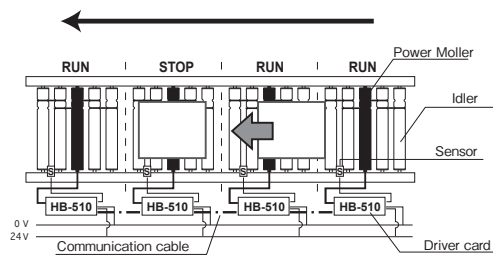

- Only the zones with the sensor OFF run

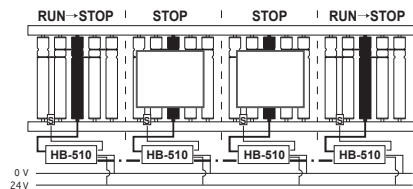

- Stops when the sensor gets ON.
- It stops after the time set on sensor timer even the sensor is OFF.

[Forcible RUN Function]

- While SW2#8 is set to ON, turning the input signal ON to the input terminal (CN2-5) causes Power Moller to run.
- When turning the input signal OFF to the input terminal (CN2-5), Power Moller stops after the time set on the RUN hold timer (when SW2#6 is ON). Then normal ZPA transfer operation starts.
- This function is convenient for setting at the most upstream or most downstream.

< When using the function in the most upstream line >

It can pull-in a load from other lines.

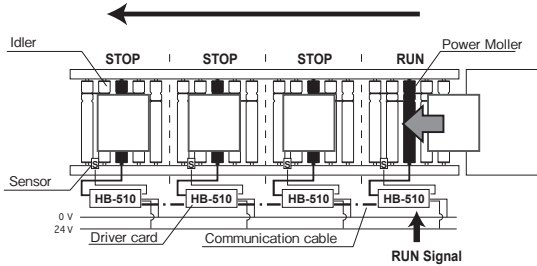

- With input terminals ON (RUN signal input), it runs until the own zone sensor gets ON.

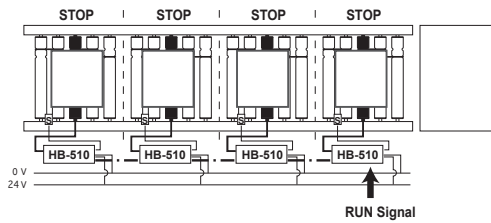

- Even with input terminals ON (RUN signal input), it stops when the own zone sensor gets ON*.
- *This occurs when a load exists in the downstream. If no load exists in the downstream, it keeps running to transfer the load to the downstream.

< When applied to the most downstream line >

- It can feed the load to other lines.
- Note) This is the operation of the most downstream setting (SW2#6 OFF).

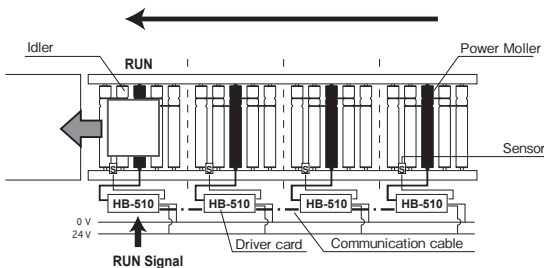

- With input terminals ON (RUN signal input), Power Moller runs.

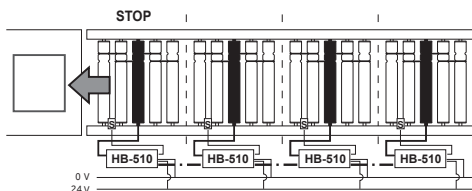

- With input terminals OFF (no RUN signal input), Power Moller stops.

[Forcible Stop Function]

- While SW2#8 is set to OFF, turning the input terminal (CN2-5) ON causes the zone to stop the carry-out operation.
(It runs carry-in operation until the sensor gets ON).
- Input terminal (CN2-5) OFF causes normal ZPA transfer operation
- This is convenient for separating a load in the middle of a line, or creating an operation space.

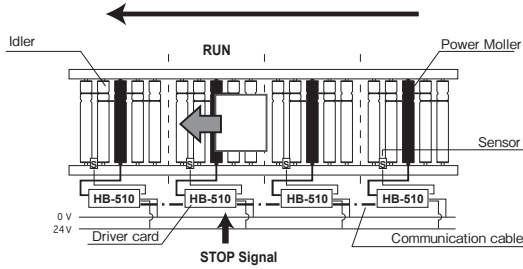

- Until the own zone sensor is turned ON, it runs/stops by ZPA condition.

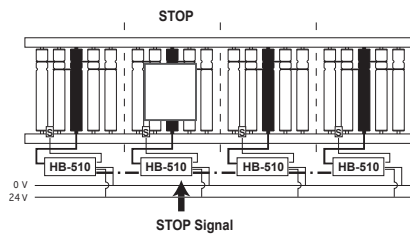

- It stops with the own zone sensor ON and does not carry out the load.
- Sensor OFF causes normal ZPA operation (in this case carrying out).

[Transfer Direction Change]

- While SW1#7 is OFF, turning the DIR terminal (CN2-4) ON (signal input) changes the transfer direction.
- Not only the roller rotation direction, ZPA transfer direction also changes.
- This is convenient for diverting and into/out-of a storage line operation.

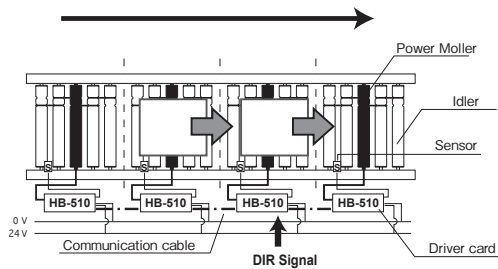

- ON (signal input) changes the transfer direction.
(Roller rotates in CW direction when viewed from the Power Moller power cable side)
- Signal input from a position on any board changes the upstream/downstream relationship of *all zones.
- There is no need to enter signal to each driver card.

*This applies to the case when block setting is turned ON (transmit).
Control from 1 location is max 30 zones.

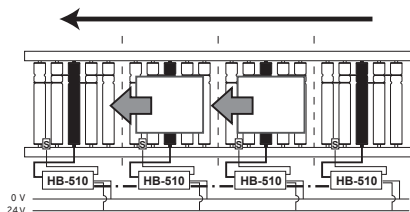

- OFF signal returns to normal transfer direction (CCW direction when viewed from the Power Moller power cable side).

[Speed Control]

- Speed change of the transfer line can be made internally by operating the rotary switch on the driver card or by applying external voltage input (to the V-in terminal <CN2-3>).
- Speed change is enabled by SW1#6 ON and external voltage input (to the V-in terminal <CN2-3>), or SW1#6 OFF and internally control (by operating the rotary switch on the driver card).
- Speed change can also be made by using both internal and external control.

< In the case of internal (rotary switch on the driver card) speed change >

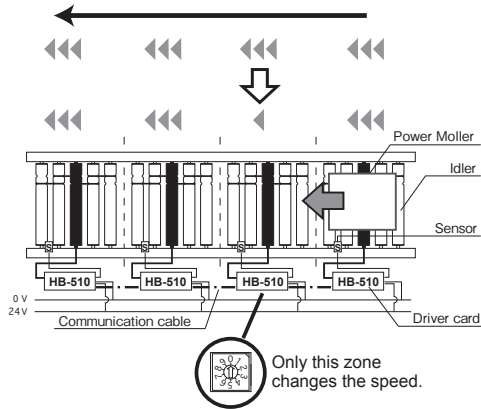

- SW1#6 OFF enables internal speed change (rotary switch on the driver card in 10 steps).
- This method is not disturbed by external voltage input.
- Speed change is applied only to the set zone (Power Moller).

< In the case of speed change by external voltage input (V-in terminal <CN2-3>) >

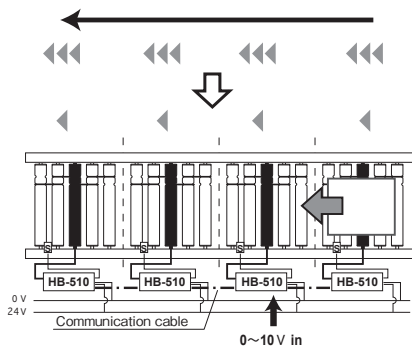

- SW1#6 ON enables external speed change (by voltage input to V-in terminal <CN2-3>).
- Voltage input of 0~10V at one position of any driver card changes speed of *all zones connected by communication cable (in 10 steps).
- There is no need to enter signal to each driver card.

*This applies to the case when block setting is turned ON (transmit). Control from 1 location is max 10 zones.

[Block Setting]

- A block (partition) consisting of multiple zones can be made in a line connected by communication cable.
- Any block (partition) only can be individually controlled.
- SW1#1~#5 enable/disable setting of signal transmission.
- Setting "No transmission" cuts out transmission to the right-hand side of the driver card regardless of upstream or downstream (Only external voltage speed change enables individual setting to the left or right).
- Individual setting can be made for speed change by external voltage input, transfer direction, error transmission and emergency stop.
- This function is convenient when requiring individual control in each zone of a line.

< When setting "no error signal transmission" only to [C] >

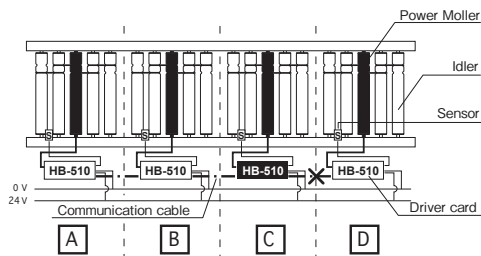

- Error occurred in [B] → Error signal output [A] [B] [C]
- Error occurred in [C] → Error signal output [A] [B] [C]
- Error occurred in [D] → Error signal output [D]

< When setting speed change of [B] [C] "not to transmit to the left side" but "transmit to the right-hand side" (SW1#4 OFF, SW1#5 ON) > (When setting speed change by external voltage, signal transmission was set on [A] and [D] to both left and right)

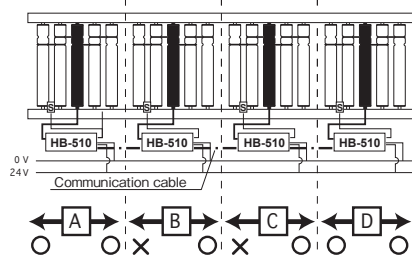

- Speed change voltage input to [D] → [C] and [D] change speed.
- Speed change voltage input to [C] → [C] and [D] change speed.
- Speed change voltage input to [B] → *Only [B] changes speed.

*[B] is set for "transmission to the right" but because the right-hand driver card [C] is set for "not to transmit to the left", thus no signal transmission takes place.

[Synchronous Output]

- While SW2#2 is ON, OUT A terminal (CN2-2) delivers signal output at the time of starting the own zone Power Moller.

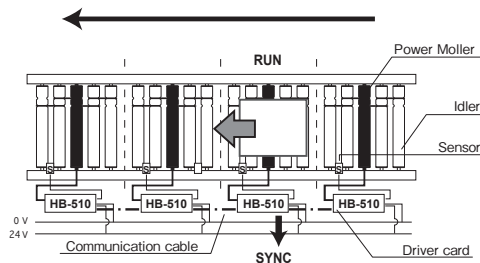

- Power Moller RUN delivers signal output.

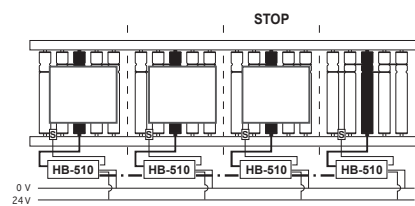

- Power Moller STOP stops signal output.

In addition, emergency stop function and sensor signal output function are also included.

[Intelligent Timer Function]

- Combination of JAM timer, RUN hold timer, and sensor timer helps provide smooth transfer and avoid line troubles.

< When a load is stuck at a sensor >

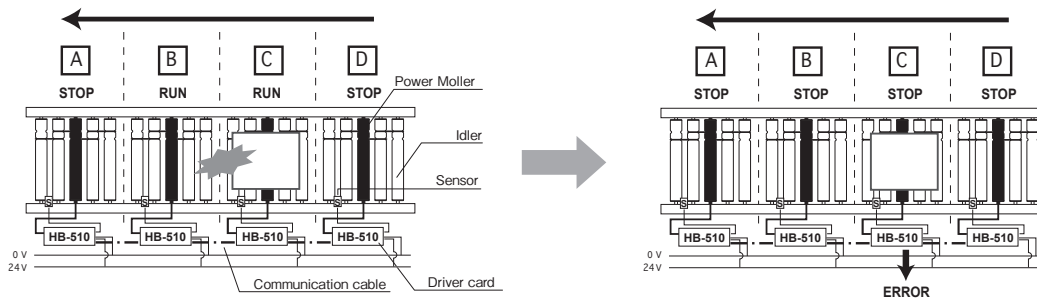

- [C] stops and generates error by the stuck load.
- Error signal is generated from *all zones connected by communication cable.
- [B] stops at the same time as the stop of [C] zone.

*This applies to the case when block setting is turned ON (transmit). Control from 1 location is max 30 zones.

< When a load is stuck between sensors >

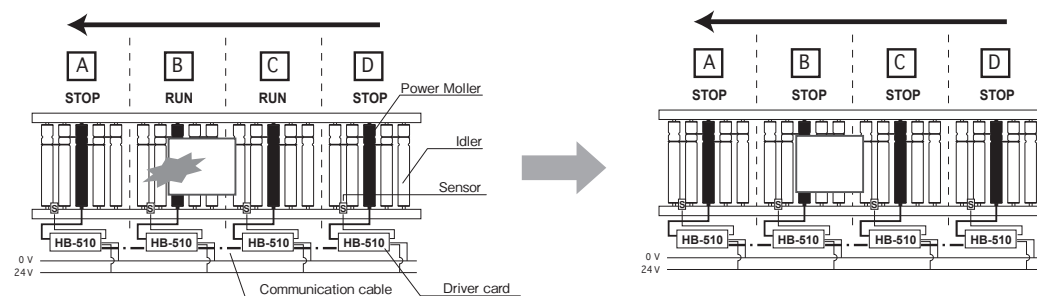

- Both [B] zone and [C] zone stop at the same time after the set time.
- No error signal is generated.

[Dimensions]

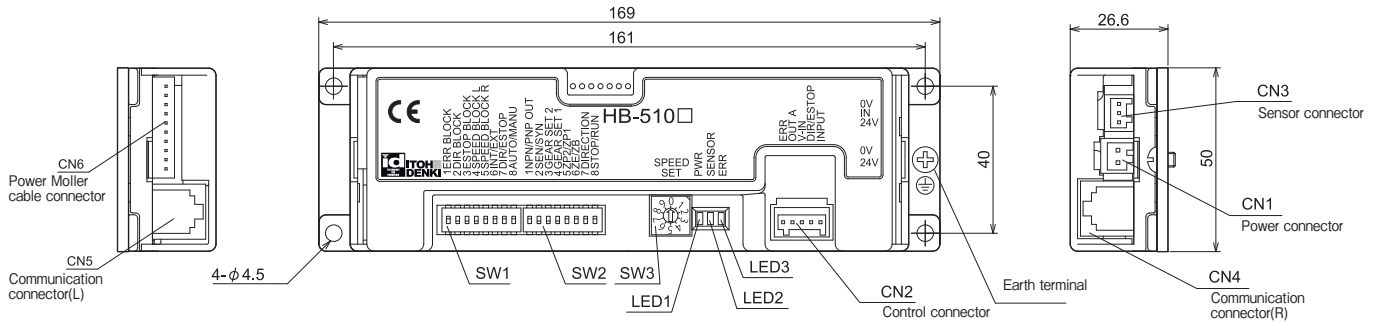

● SW1

No	Function	ON	OFF
1	Error signal transmission to the right adjacent zone	Valid	Invalid
2	Direction signal transmission to the right adjacent zone		
3	Emergency stop signal transmission to the right adjacent zone		
4	Speed variation signal transmission to the left adjacent zone (external voltage change)		
5	Speed variation signal transmission to the right adjacent zone (external voltage change)		
6	Selection of internal or external speed variation	External (voltage input)	Internal (SW3 pot.)
7	Selection of direction signal input or emergency stop signal input (CN2-4)	Emergency stop signal input	Direction signal input
8	Selection of recovery for thermal or low voltage error	Maunal	Automatic

● SW3

Rotary switch for 10 index speed variation (when SW1-6 is set to OFF)

● LED

LED 1	Green	Power status. Activates Power Moller
LED 2	Orange	Error on sensor or jam error
LED 3	Red	Error on sthermister, notor block or current limiter, Low voltage

● SW2

No	Function	ON	OFF																																						
1	Selection of internal or external speed variation	PNP output	NPN output																																						
2	Selection of sensor signal output or synchronization signal output	Synchronization signal output	Sensor signal output																																						
3	※1 Power Moller nominal speed setting	<table border="1"> <thead> <tr> <th colspan="2">Nominal speed</th> <th colspan="2">Switch setting</th> <th colspan="2">Timer set time (S)</th> </tr> <tr> <th>FE</th> <th>FP</th> <th>#3</th> <th>#4</th> <th>Sensor / Run hold</th> <th>JAM</th> </tr> </thead> <tbody> <tr> <td>210</td> <td>255</td> <td>OFF</td> <td>OFF</td> <td>0.3~1.2</td> <td>0.6~2.2</td> </tr> <tr> <td>60</td> <td>55</td> <td>OFF</td> <td>ON</td> <td>1~4</td> <td>2~8</td> </tr> <tr> <td>17</td> <td>15</td> <td>ON</td> <td>OFF</td> <td>4~14</td> <td>7.5~27</td> </tr> <tr> <td>—</td> <td>—</td> <td>ON</td> <td>ON</td> <td colspan="2">Forcible RUN ※</td> </tr> </tbody> </table>				Nominal speed		Switch setting		Timer set time (S)		FE	FP	#3	#4	Sensor / Run hold	JAM	210	255	OFF	OFF	0.3~1.2	0.6~2.2	60	55	OFF	ON	1~4	2~8	17	15	ON	OFF	4~14	7.5~27	—	—	ON	ON	Forcible RUN ※	
Nominal speed		Switch setting		Timer set time (S)																																					
FE		FP	#3	#4	Sensor / Run hold	JAM																																			
210		255	OFF	OFF	0.3~1.2	0.6~2.2																																			
60	55	OFF	ON	1~4	2~8																																				
17	15	ON	OFF	4~14	7.5~27																																				
—	—	ON	ON	Forcible RUN ※																																					
4		※Forcible RUN ceases when sensor in present and downstream zone is blocked.																																							
5	Selection of ZPA release mode	Slug (train)	Singulated																																						
6	Downstream end setting	Invalid		Valid																																					
7	Motor direction	FE CCW	FS/FP CW	FE CW	FS/FP CCW																																				
8	Selection of input terminal function	Forcible RUN		Forcible STOP																																					

※1 Speed variation in the table is achieved only by the correct combination of the Power Moller nominal speed and dip switch settings.

[Wiring diagram (HB-510N)]

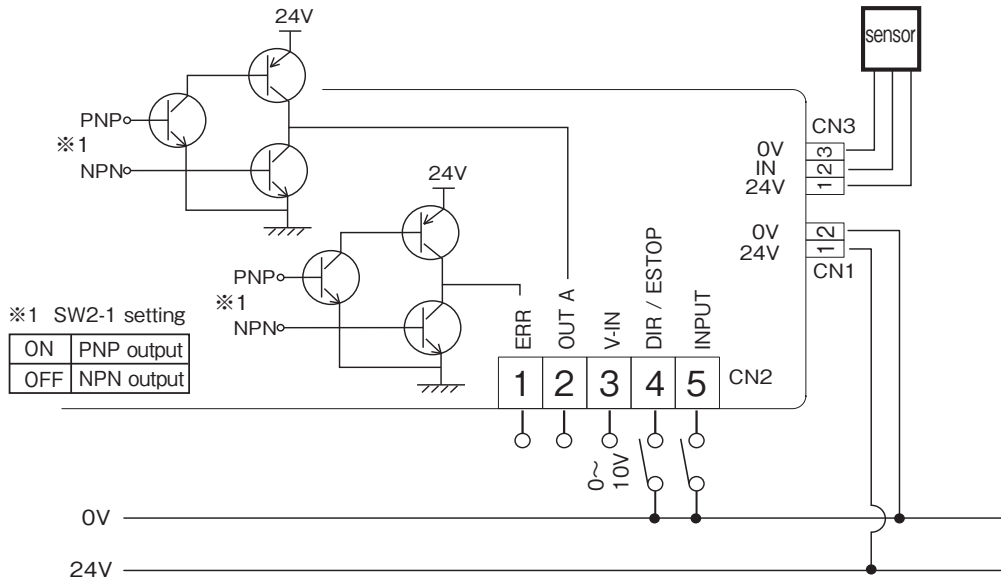

[Specifications]

Power voltage	24V DC ± 10%	
Rated voltage	24V DC	
Static current	0.06A	
Peak current	20A 1msec以下	
Starting current	4.0A	
Input	Sensor	NPN / PNP
	Forcible run/stop	NPN / PNP
	Direction	NPN / PNP
	Emergency stop	NPN / PNP
	External speed variation	0-10V DC
Output	Sensor	NPN/PNP open collector (※1)
	Error	NPN/PNP open collector (※1)
	Synchronization	NPN/PNP open collector (※1)
LED indication	Error (red) Power status (green) Sensor status (Orange)	
Protections	Integral 7A fuse (+ side) Integral diode against miss wiring	
Thermister	Reacts at 85°C on circuit board, or 105°C on motor	

	Brake	Electric brake
HB card side	Power connector	WAGO734-162 (max:10A)
	Sensor connector	WAGO733-363 (Max:4A)
	Control connector	WAGO733-335 (Max:4A)
Wiring side	Power connector	WAGO734-102 (Max:10A) Wire diameter 0.5~1.5mm ² [AWG:20~14]
	Sensor connector	WAGO733-103 (Max:4A) Wire diameter 0.08~0.5mm ² [AWG:28~20]
	Control connector	WAGO733-105 (Max:4A) Wire diameter 0.08~0.5mm ² [AWG:28~20]
Motor connector	JST S9B-XH-A	
Environment	Ambient temperature	0~40°C (※3)
	Relative humidity	≤ 90%RH (no condensation)
	Atmosphere	No corrosive gas
	Vibration	≤ 0.5G
Mechanical Brake (※2)	From electrical stop to brake engagement	400msec
	Brake current	During brake activation: 0.2A

※1 PNP or NPN signal selectable by dip switch

※2 Applicable only for HB 510BN or HB 510BP for Power Moller with built-in brake

※3 It is not available at ambient temperature of 0 °C or less for LT.