



Multi Angle Transfer Module

MABS

Multi Angle Ball Sorter

< User Manual >



Read this manual before use

Thank you for purchasing the Multi-directional Transfer Module (hereinafter referred to as "this product").

※This product refers to all products including standard accessories.



Make sure to read this manual carefully before using, and start using only after you have understood all the product's functions, safety information and precautions.

After reading the manual, make sure to keep it safe in a specified place for future use, whenever necessary.

This User Manual is intended to be written under control using not network communications, but digital I/O, such as PLC signals.

1. Introduction

Features

- This product is a module to enable the user to divert totes.
- This compact diverting module can set the diverting angle freely.
- All-electric control. No pneumatics, which do not require compressor.

Operation description (when diverting)

Load

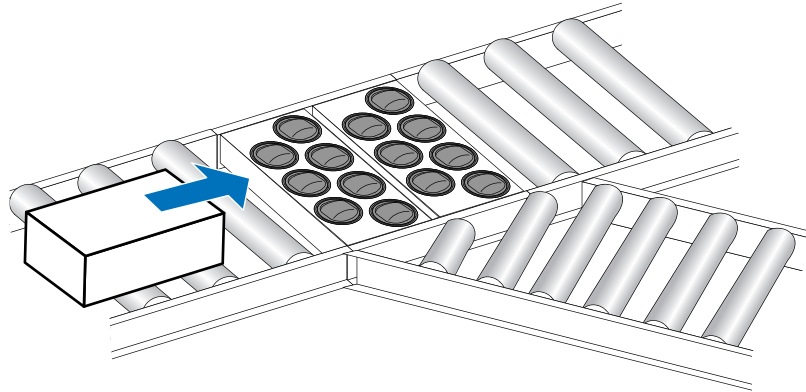

The transfer ball section
swings to the
diverting direction

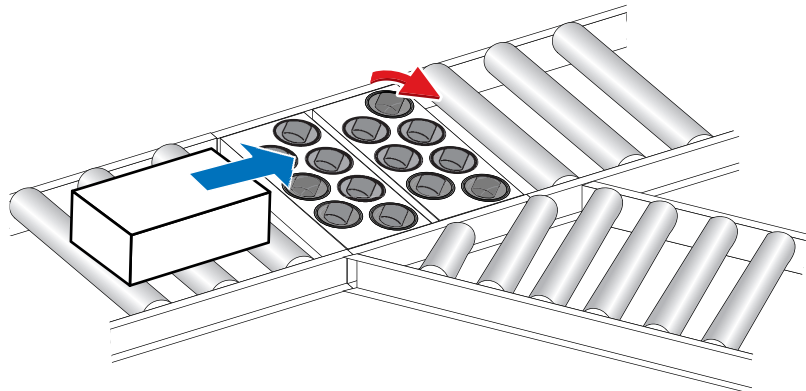

Discharge

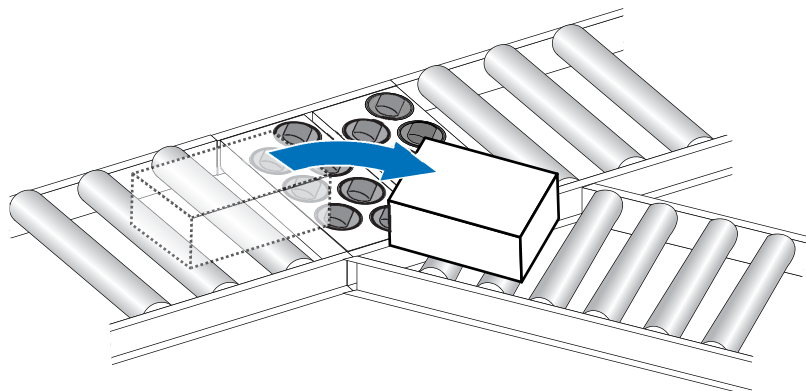

The transfer ball section
swings to the
straight direction

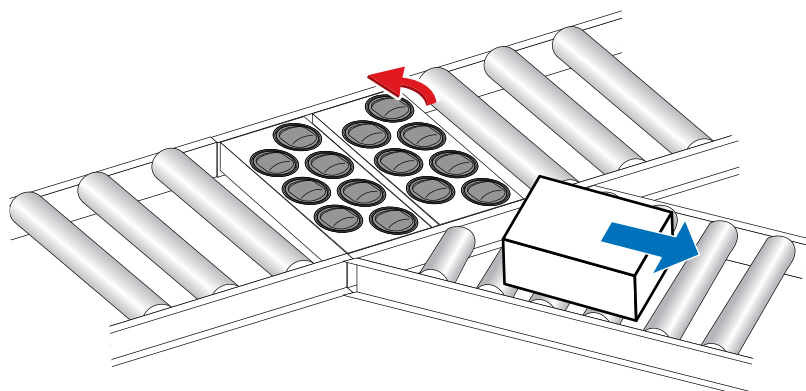

1. Introduction

Disclaimer

- This product is designed as a general industrial device. Do not use for other applications. We do not take any responsibility for any damage that may result from the disregarding of these warnings.
- In the event that an accident results from the use of this product, we do not compensate for any damage, including abnormalities of equipment, connection devices, and/or software, any damage resulting from malfunctions, and/or any other secondary damage.
- Caution : Installation, operation and usage of ITOH DENKI MDRs in combination with a control card designed by a third party could result in fatal phenomena such as fire, electric shock, injuries etc which are out of the responsibility of ITOH DENKI.

Notes on industrial property rights

There are some examples of parts that need to be prepared by customers, as explained within this manual. However, this does not provide any guarantee against the existence of any rights, such as our industrial property rights, or those of other companies.

Notes on technical support

We respond to technical inquiries based on the contents described within this manual, and on this product within the range of general items for this product unit.

There are some descriptions in this manual, about parts, equipment, and wiring arranged by customers, as well as the controls and operation under such circumstances. However, these are not included in the guaranteed operating range and/or support.

When in use, please check and perform the aforementioned based on your responsibility according to operation.

About the performance level (PL) for this system

This product is based on the performance level "C"^{*2} in ISO-13849-1^{*1}.

*1 : International Organization for Standardization

*2 : This indicates that even though events that would result in serious injury occur infrequently under assumed risk environment, there is a high probability to avoid danger if you observe the safety contents described in this manual.

About installation environment

This product is not equipped with special dust proof/waterproof countermeasures, and is intended to be used in environments of "Pollution Degree 2"^{*2}, as defined in IEC60664 -1^{*1}.

*1 : Insulation coordination for equipment within low-voltage supply systems - Part 1 of the International Standard

*2 : Non-conductive pollution will occur, but it is assumed that condensation will happen to generate conductive property temporarily.

About description of the product

- Depending on the signal type (NPN/PNP) specified by customers, different models of controllers are supplied as being the standard for this product.

Signal input/output type	NPN	PNP
Included controller model	IB-E06F-N-UL-M1	IB-E06F-P-UL-M1

In this manual, IB-E06F-N-UL-M1 and IB-E06F-P-UL-M1 are described as IB-E06F-M1, and IB-E06F-N-UL-M1 and IB-E06F-P-UL-M1 are described separately, when needed.

- Illustrations and wiring images in this manual are described under the assumption that two units of this product are to be synchronized and controlled. When the number of synchronized units is different, or multiple units of this products are to be controlled separately, perform wiring and control according to the respective conditions.

2. Procedures from installation to operation

Procedures from installation to operation

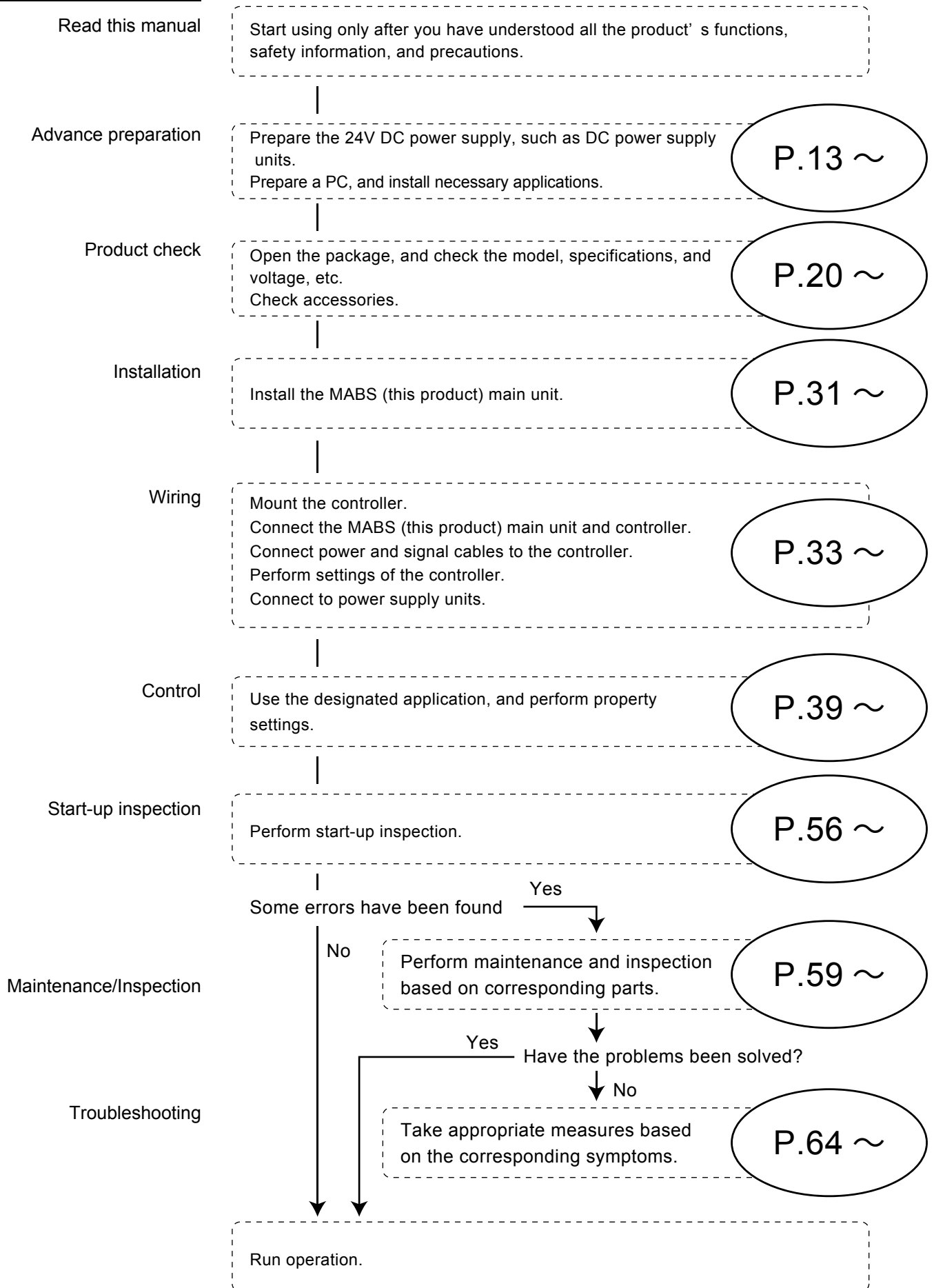

2. Procedures from installation to operation

INDEX

1. Introduction	2
2. Procedures from installation to operation	4
3. Safety precautions	6
3-1. General precautions	8
3-2. Precautions on installation	9
3-3. Precautions on wiring	10
3-4. Precautions related to operation	10
3-5. Precautions on maintenance and inspection	11
4. Advance preparation	12
5. Product check	19
6. Structures	21
7. Installation/Wiring	23
7-1. Before installation	24
7-2. Installation	31
7-3. Wiring	33
8. IB-E06F-M1 settings	38
8-1. Setting preparation	40
8-2. Property settings	43
9. Control/Operation	49
9-1. Before starting control	50
9-2. About swing control	52
9-3. Basic operation	53
9-4. What to do before operation	56
10. Maintenance/Inspection	58
10-1. Controller's LED display	59
10-2. Checking and releasing errors	62
10-3. Before replacement work	64
10-4. Replacement of the transfer ball element set/Grease filling procedure	65
11. Troubleshooting	68
Appendix	71
Appendix 1. Product specifications	72
Appendix 2. Replacement parts/Options	74
Appendix 3. Residual risk list/MAP	75

3. Safety precautions

For parts names in sentences, refer to 6. Structures (P.21).



3-1. General precautions	8
3-2. Precautions on installation	9
3-3. Precautions on wiring	10
3-4. Precautions related to operation	10
3-5. Precautions on maintenance and inspection	11

3. Safety precautions

Danger level



To prevent hazards to users and/or others, and/or damage to property in advance, we explain important precautions to be followed securely as below.

- The degree of hazard and/or damage that may result if a user disregards the description and operates the product improperly is categorized as the following symbols and explained below.

 WARNING	This indicates a high possibility that severe injury may result.
 CAUTION	This indicates a high possibility that injury, or only property damage may result.

Symbol explanation

- The type of precautions is categorized as the following symbols and explained below.

	This symbol indicates a reminder which users should pay attention to.
	This symbol indicates operations that are prohibited.
	This symbol indicates forced operations that users should always perform.

3. Safety precautions

3-1.

General precautions



WARNING



Do not use the product near places subject to explosive, flammable gas, and/or corrosive atmosphere, and/or combustible materials.

Failure to follow this could result in explosion, fire, electric shock and/or injury.



When using the product in places where serious accidents and/or damage may possibly occur, install backup and/or fail-safe functions systematically.

Failure to follow this could result in the inability to control this product due to controller malfunction, which could lead to serious accidents.



CAUTION



Do not apply heavy loads to this product, such as stepping on it.

Failure to follow this could result in people falling and/or malfunction.



Do not come into contact with the moving parts, such as transfer balls, and/or allow clothes to get close to them.

Failure to follow this could result in objects/body parts getting caught and/or stuck.



Never remodel the product.

Failure to follow this could result in serious accidents. We assume no responsibility for remodeled products.



Make sure to attach ground wires to this product.

Failure to follow this could result in electric shock if any malfunction or leakage occurs.



Do not put water and/or oil on the product, and do not transfer wet and/or oily totes.

Failure to follow this could result in electric shock, and/or malfunction.



Do not apply strong impact and/or excessive force to the product, such as hitting it with objects, or dropping it.

Do not use the product of which the appearance has become deformed.

Failure to follow this could result in malfunction.



Stop operation when abnormal sound is heard during operation.

Failure to follow this could result in unexpected accidents.



Do not use in a way exceeding the range of the product specifications.

Failure to follow this could result in malfunction, fire, and/or injury.



Turn off the power supply to the product before moving, installing, and/or wiring the product, and before performing maintenance and inspection (excluding cases when the power is to remain turned on).

Working while the power is on could result in unexpected accidents.

3. Safety precautions

3-1. General precautions

⚠ CAUTION



Do not turn on/off relays and/or contactors near power cables, signal cables, and/or controllers.
Failure to follow this could result in malfunction due to noise generation.



LED or Pull-up/Pull-down circuits implemented in the output circuit of control devices could result in unexpected operation.
Carefully check the output circuit.



Turn ON the power in order of external control devices, and then this product.
Turn OFF the power in order of this product, and then external control devices.
Turning ON/OFF the power in the wrong order could result in malfunction.



Do not forcibly rotate transfer balls in their stopped state with external force.
Failure to follow this could result in damage to controllers, and/or their lifetime to be significantly shortened.



When disposing of the product, make consigning contracts with licensed industrial waste disposers, and consign the disposal to them.

3-2. Precautions on installation

⚠ WARNING



Have the appropriate number of persons assist when carrying and/or installing the product.
Use the elevating carriage, etc., and move the product to the level of installation.

⚠ CAUTION



When handling, wear protective equipment, such as gloves.
Failure to follow this could result in hands getting injured by metal parts.



Make sure to use the recommended tightening torque to tighten bolts for installing the MABS main unit and/or fastening screws of controllers.
Failure to follow this could result in bolts and/or screws loosening, and/or malfunction.



Do not lift this product with goods loaded.
Failure to follow this could result in injury, accidents, and/or damage due to load collapse.

3. Safety precautions

3-2.

Precautions on installation

CAUTION



Take appropriate measures to prevent totes from popping out of the equipment.

For example, mount guide rails on the conveyor frames.
Failure to follow this could result in workers getting injured by totes popping out of the equipment.



If necessary warning/caution labels become hidden after installation, affix again on places where they can be seen.

3-3.

Precautions on wiring

CAUTION



When attaching or removing connectors, turn off the power first, securely hold connectors, and perform operation.

Do not apply excessive force to the controller connection parts, such as obliquely attaching or removing connectors.

Failure to follow this could result in electric shock, malfunction, and/or accidents due to unexpected operation.



Perform wiring to connectors so that cables make secure contact with connectors.

Barb lines from the cable core could result in heat generation and/or fire due to changes of contact resistance, and/or short circuit with the adjacent contact.



Do not forcibly bend and/or pull cables.

Do not put heavy materials on cables, or do not get them stuck between cables.

Failure to follow this could result in fire and/or electric shock due to cable damage.

3-4.

Precautions related to operation

CAUTION



Do not forcibly move totes when they are placed on transfer balls.

Failure to follow this could result in damage and/or malfunction.



Make sure to perform the start-up inspection before starting operation.

Wear protective equipment, such as gloves.



Do not unplug power and/or signal cables during operation.

Do not run/stop this product using the power supply.

Failure to follow this could result in malfunction.



In the event that any abnormalities occur, for example, if abnormal noise is heard from the product, the temperature becomes high, or electric leakage occurs, turn off the power immediately.

Failure to follow this could result in unexpected injury.

3. Safety precautions

3-5.

Precautions on start-up inspection/ maintenance and inspection

WARNING



If any abnormalities are found, do not use this product until the causes have been eliminated completely.

Using this product with unattended abnormalities could result in not only damage to the devices, but also unexpected accidents.



Have specialists (or people who have sufficiently acquired skills) perform maintenance and inspection under instructions by management supervisors.



At the time of maintenance and inspection, post warning labels so as to prevent unauthorized persons from turning on the power.

Failure to follow this could result in unexpected accidents.

CAUTION



Secure the working space for maintenance around this product.

Working in the forced position could result in unexpected accidents.



For maintenance and inspection, wear protective equipment, such as gloves.

Failure to follow this could result in hands getting injured by metal parts.



Do not disassemble sections and/or parts other than those specified.

Failure to follow this could result in malfunction and/or unexpected accidents.



Make sure to prepare maintenance parts designated by ITOH DENKI.

Using parts other than those designated by us could result in malfunction.



Perform maintenance and inspection in a "Pollution Degree 2" environment, as defined in IEC60664-1.



When disassembling the product, make sure to fully understand the maintenance and inspection contents before working.

4. Advance preparation

4. Advance preparation

Wiring image

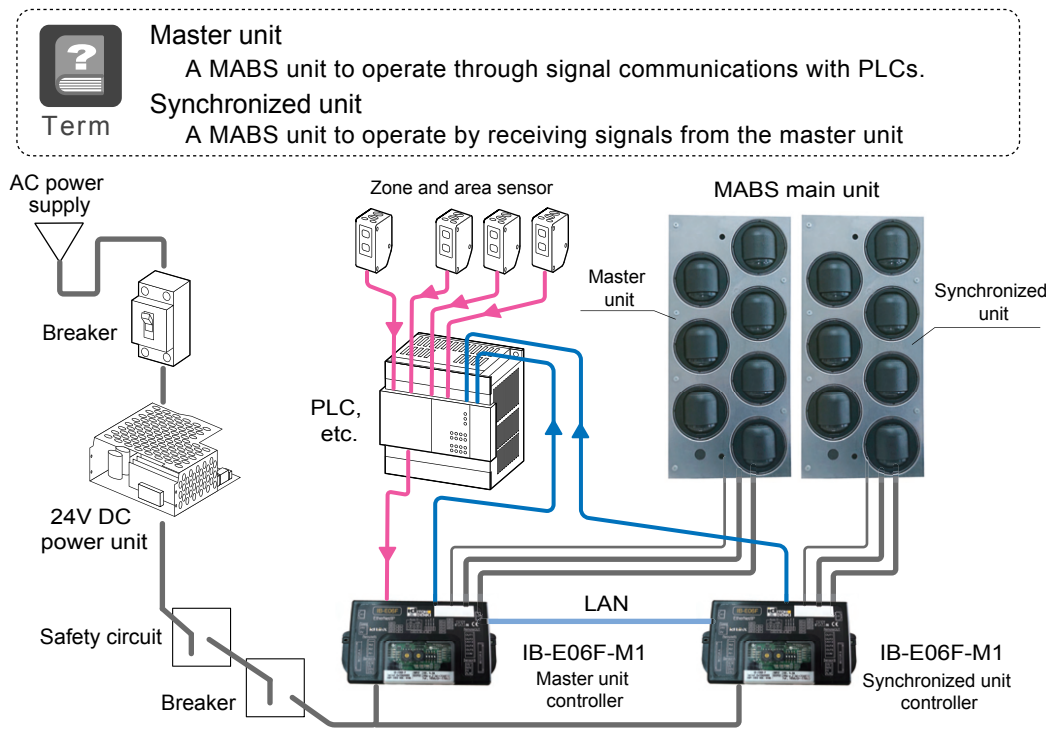

※MABS units can also be operated individually by inputting/outputting signals from PLCs to each IB-E06F-M1

- As for the sensor input, and input/output signals of controllers, adopt the number of inputs/outputs based on customers' operation. (Details => P.34)
- The safety circuit includes the emergency stop equipment and magnet contactor.

Items to be prepared by customers

- ① 24V DC power supply

Before introducing this product prepare the following devices separately.

Power supply equipment to supply 24V DC to this product (for two units) ※

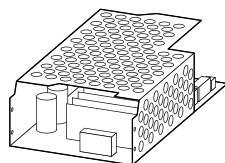

- Switching power supply (24V DC/30A, 720W or more) ※
- 24V DC battery

※Specifications for one unit are 24V DC/15A, 360W or more.

- A switching power supply is recommended as the DC power supply (24V DC±10%) for controllers.
- Use a stabilized power supply that has an adequate capacity of 24V DC and 15A or higher per 1unit and does not fluctuate due to load variation.
- A transformer type power supply cannot be used.
- Secure a voltage of 24V DC±10% at the power supply terminal of a controller.
- If the power supply capacity is less than the rated power of this product, it may result in malfunction and/or damage due to the supply voltage drop. Be sure to use a power supply with a capacity larger than the rated power of this product.
- The power supply should not activate protection with peak current 30A, 1 ms or below per 1unit.
- For the power supply unit, use an isolation type switching power supply compliant with the safety standard (IEC62368-1). Do not use a non-isolation type power supply for safety reasons, since it may not conform to the radiation noise regulations.

Safety precautions
Advance preparation
Product check
Structures
Installation/Wiring
IB-E06F-M1 settings
Control/Operation
Maintenance/Inspection
Troubleshooting
Appendix

4. Advance preparation

② Control devices

Devices to control this product, such as PLCs

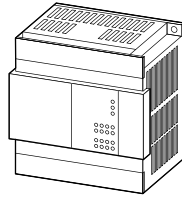

③ Sensors

Zone sensors to check the tote, and area sensors to check loading and discharging, etc.

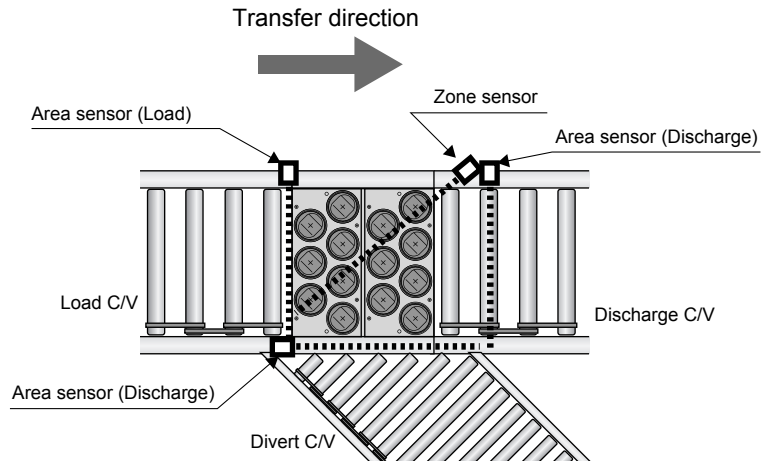
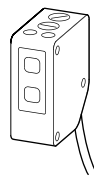

Zone sensor

A sensor to detect the existence of totes within the zone

Term

Area sensor

A sensor to detect load and discharge of totes to/from the zone

④ Wiring materials

Necessary for wiring of power and signal cables to the controller.

〈Available wire diameter for controller connectors〉

Connector	Controller	IB-E06F-M1
Power connector		1.25~2.5mm ² (AWG : 16~12)
Control connector		0.08~0.5mm ² (AWG : 28~20)



- To select the current capacity of wiring materials, secure a high safety margin based on the current value in the equipment to be used.
- Longer wiring between the power supply unit and controllers could cause the voltage to decrease, resulting in malfunction and/or damage.

4. Advance preparation

⑤ PC

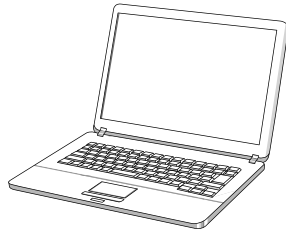

PCs that meet the following requirements

- OS: Microsoft Windows 7 or later
- CPU: CPU core i5 or higher
- Memory: 4GByte or more
- .NET Framework Ver.4.5 or higher
- CRT resolution: 1024×768 [XGA]
- Keyboard/Mouse (Touch operation unavailable)

⑥ LAN cable

Necessary for communications with IB-E06F-M1. (Category 5e or more)

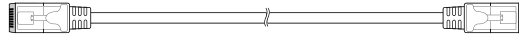

⑦ Application

Installing the designated application

For IB-E06F-M1 settings, the following two files are necessary.

- iCEP Lite
- Comment file

Download from ITOH DENKI web page.

https://www.itohdenki.co.jp/e_softdl.html

※ Top page>Download/Support>Software and setting file download



■ Illustrations explained and/or procedures may partly differ depending on your PC.
 In such cases, perform settings and operations to ensure the application will be safely installed of your own accord, and under your own responsibility.

⑦-1 iCEP Lite Installing

1 Start the iCEP Lite setup program.



2 Proceed to the installation according to the instructions on the screen.

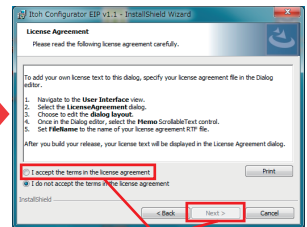
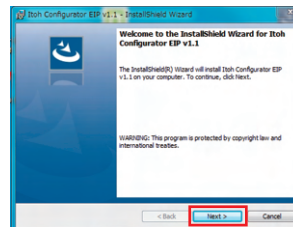

Click

Accept the license agreement articles, and click

※When the following screen is displayed during installation, click "Yes".

3 Click to start installation

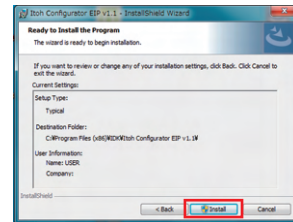

Click



4 When installation is complete, the iCEP Lite icon will be displayed on the PC's desktop.

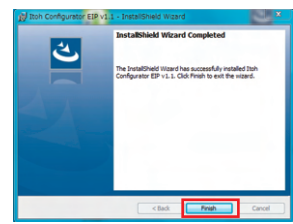

Click



⑦-2 Importing the comment file

1 For details on how to import the comment file, refer to P.43.

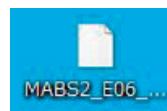

「MABS2_E06_V×××.lpg2」

(The version of the downloaded file is indicated in xxx.)

4. Advance preparation

⑧ Designated stay
(Option)

• A stay used to install the MABS main unit. For details on how to mount, refer to P.31.

! ■ Designated stays and mounting bolts are not included. Order separately.
 ■ When installing the MABS main unit, make sure to use the designated stay.
 If stays other than those designated have been used, the warranty will not be valid.

⑧-1 Product designation

Indicates the product for one stay. Two stays are necessary for one unit.

MABS - FST 400 B

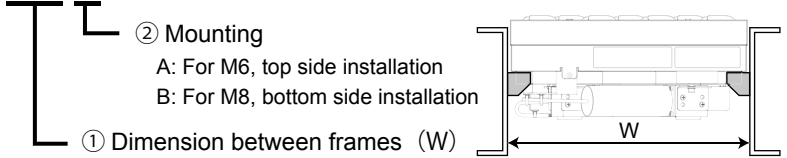

⑧-2 For M6

This is used when securing the MABS main unit on the top side.

※Customers must remove the top cover of the MABS main unit, and fasten the main unit and stay.

Dimension between frames/W (mm)	A
For W=400 to 415	(W-400)+2+30
For W=500 to 515	(W-500)+2+30
For W=600 to 615	(W-600)+2+30
For W=700 to 715	(W-700)+2+30
For W=800 to 815	(W-800)+2+30

※W indicates the dimension between frames on which this part is mounted.

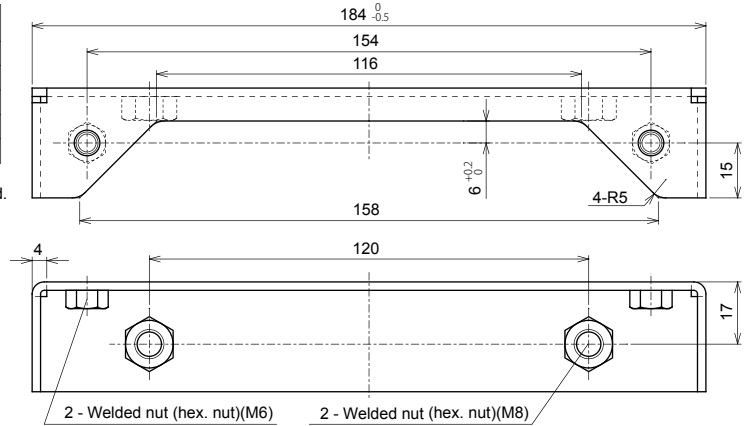
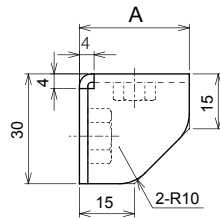

Bolt for mounting

For mounting the stay **2 sets**

Hex. socket head bolt (M8) x 16 Spring washer (M8) Plain washer (M8)

For installing MABS **2 pieces**

Hex. bolt with spring lock and plain washers (M6) x 25

⑧-3 For M8

This is used when securing the MABS main unit on the bottom side.

Dimension between frames/W (mm)	A
For W=400 to 415	(W-400)+2+30
For W=500 to 515	(W-500) ÷ 2+30
For W=600 to 615	(W-600) ÷ 2+30
For W=700 to 715	(W-700) ÷ 2+30
For W=800 to 815	(W-800) ÷ 2+30

※W indicates the dimension between frames on which this part is mounted.

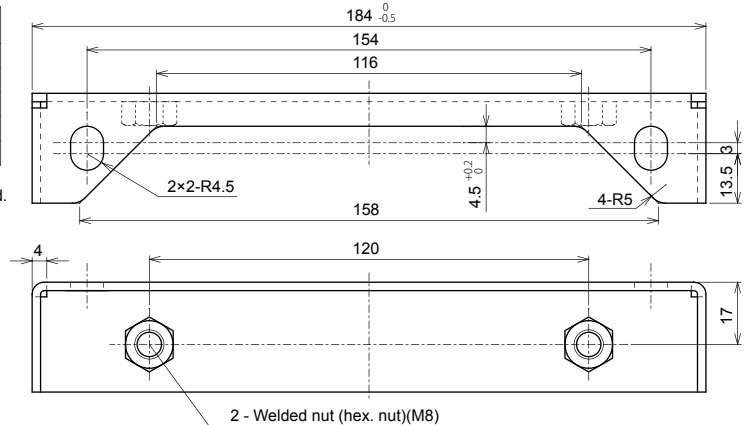
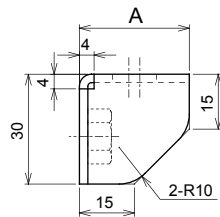

Bolt for mounting

For mounting the stay **2 sets**

Hex. socket head bolt (M8) x 16 Spring washer (M8) Plain washer (M8)

For installing MABS **2 pieces**

Hex. bolt with spring lock and plain washers (M8) x 20

Safety precautions

Advance preparation

Product check

Structures

Installation/Wiring

IB-E06F-M1 settings

Control/Operation

Maintenance/Inspection

Troubleshooting

Appendix

4. Advance preparation

⑨ Emergency stop equipment



This product does not include the emergency stop equipment. Customers must make sure to install it.

Install the emergency stop equipment on the side of the 24V DC power unit to which the power is supplied.

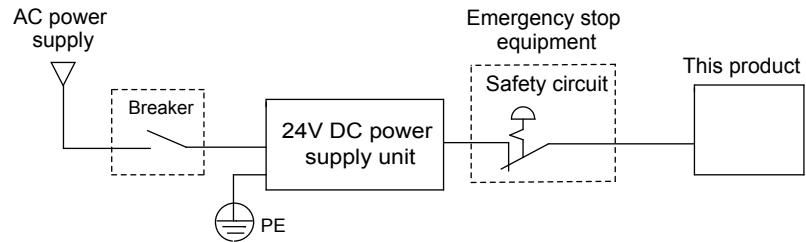

⑨-1 Checking the breaker

Regarding equipment where this product is installed, check that a breaker with appropriate capacity for AC input specifications of the 24V DC power supply unit has been installed. If abnormal operation should occur, protection through the breaker could be effective.

Note that when using an earth leakage breaker, select one that is “inverter corresponding”. Some inverter non-corresponding earth leakage breakers could result in malfunction, since they may recognize high-frequency components of the switching power supply as leakage.

⑨-2 Operation check

When the 24V DC power supply unit has been installed, check that the breaker and safety circuit can work properly. Perform operation following the trial operation after checking them.

- ① Input to the 24V DC power supply unit (AC power) is securely turned ON/OFF when turning ON/OFF the breaker.
- ② This product input (24V DC) is securely turned OFF/ON when turning ON/OFF the safety circuit.

4. Advance preparation

⑩ About the wiring method

⑩-1 When overcurrent protection devices are required

When overcurrent protection devices need to be installed to the 24V DC power supply unit, some power supplies that need to conform to the safety standards (UL60950-1, etc.) require installation of the specified overcurrent protection device based on their specifications. In such cases, make sure to install the specified overcurrent protection device as described in the figure below. When overcurrent protection devices are not required in specifications of the 24V DC power supply unit, they do not need to be installed.

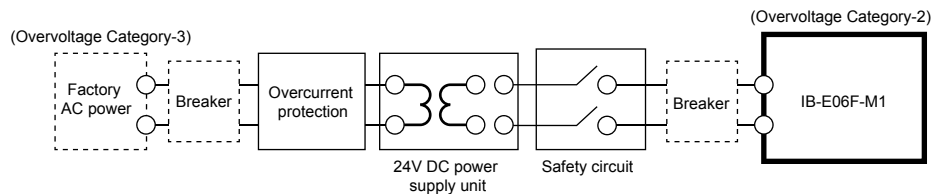

⑩-2 Installation of over-current protection device

In case of using power supply device except a limit power supply, install the over-current protection device on the 24V DC line.

⑩-3 Adding the power shutdown circuit of this product in the event of a failure

In the event that a failure occurs, such as overload or abnormal temperature, IB-E06F-M1 will transmit the data of failure generation to PLC devices, as well as stopping product operation. However, the product does not have the power shutdown function. Accordingly, if the product's power needs to be shut down in the event of a failure, as described in SW1 of the figure below, add the power shutdown circuit using a PLC.

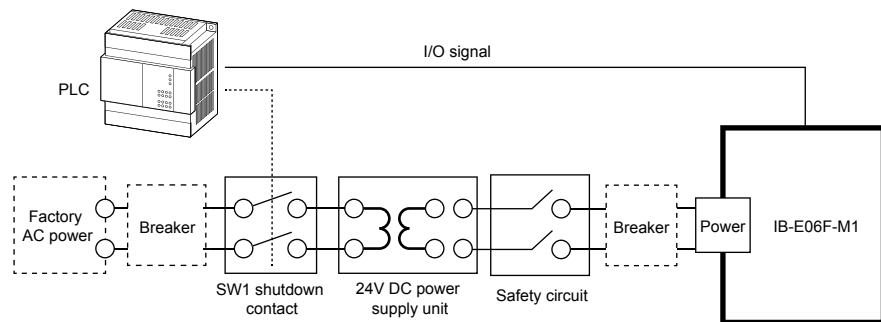

■ At the time of power shutdown, not only the MABS main unit power, but also the IB-E06F-M1 control power will be shut down.

5. Product check

5. Product check

Checking the model

Unpack the product, and check that the product model is what you ordered.



< Product label details >

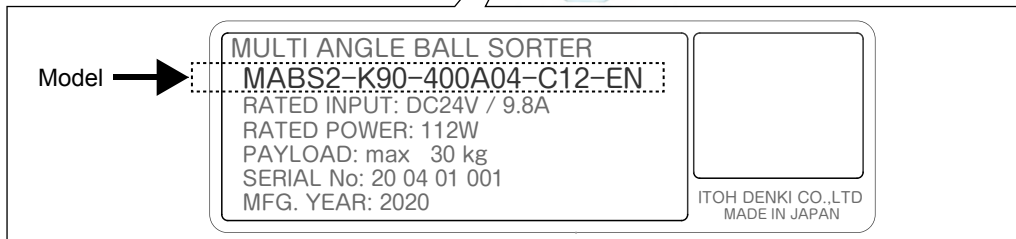

Checking appearance

- ① Check that the main unit is free from any abnormalities, such as traces of scratches, dents, dirt, and/or corrosion (rust).
- ② Check that there is no omission and/or looseness of screws.

If any abnormalities are found, contact the supplier immediately.

Checking accessories

Check that all the following items are included.

- Controller/Connectors
- Extension cable

- Depending on the sensor input signal type, controllers with the NPN (N) or PNP (P) signal input are attached.
- One set of the following items is attached per one unit.

<p>For MABS2-K90-□A□-C□-EN</p> <p>Controller IB-E06F-N-UL-M1 × 1 < For swing/transfer ></p> <p>Extension cable ※ × 2</p>		× 1 Power connector wago231-302/026-000	× 2 Sensor connector wago733-104
	× 1 Remote input connector wago734-204	× 1 Remote output connector wago734-206	
	× 2 Cross-recessed pan head screw M4×10	× 2 Spring washer M4	× 2 Hex. nut M4
<p>For MABS2-K90-□A□-C□-EP</p> <p>Controller IB-E06F-P-UL-M1 × 1 < For swing/transfer ></p> <p>Extension cable ※ × 2</p>		× 1 Power connector wago231-302/026-000	× 2 Sensor connector wago733-104
	× 1 Remote input connector wago734-204	× 1 Remote output connector wago734-206	
	× 2 Cross-recessed pan head screw M4×10	× 2 Spring washer M4	× 2 Hex. nut M4

※Cable length depends on the model. Refer to P.22.

6. Structures

6. Structures

Structures

MABS main unit



※The photo is for size 400.

Product designation

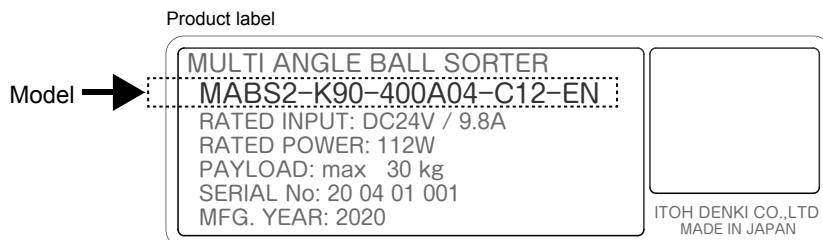

MABS2-K90-400A04-C12-EN

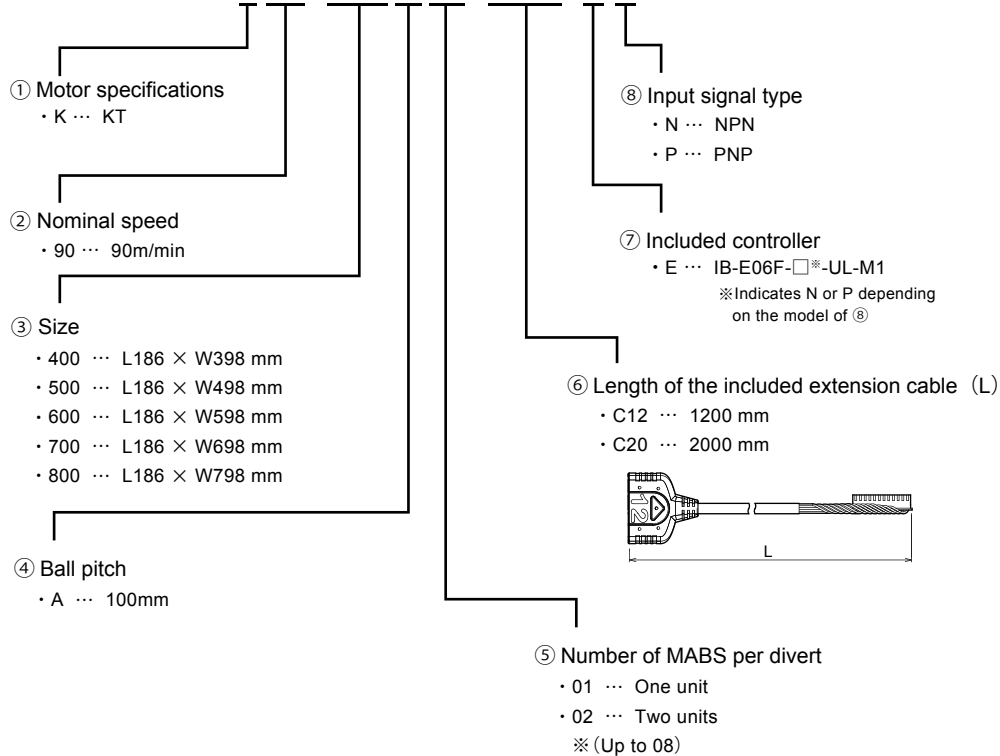

Nominal speed

Term

The speed on the transfer surface of transfer balls (m/min), and the nominal speed with a nice round value for convenience. Values differ from the actual speed.

7. Installation/Wiring

7-1. Before installation	24
7-2. Installation	31
7-3. Wiring	33

7. Installation/Wiring

7-1.

Before installation

About the MABS main unit installation position and diverting conveyor

Perform frame processing by reference to the following instructions and mounting holes of stays.

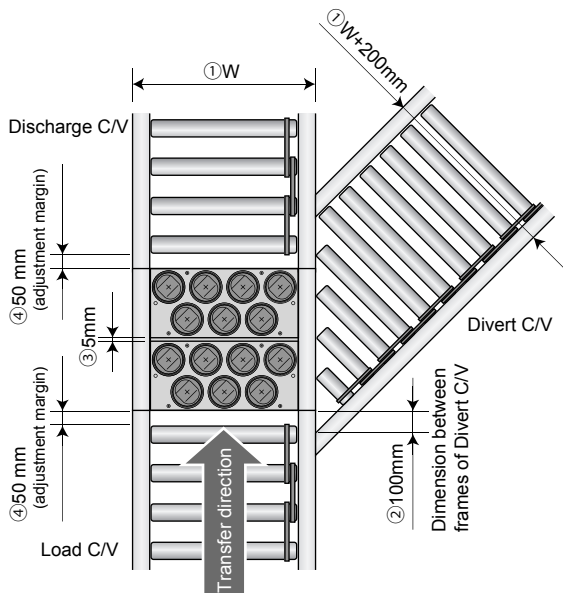

- ① Prepare the diverting conveyor to be wider than the straight conveyor $W + 200\text{ mm}$



■ The conveyor width depends on totes and/or tote position.

- ② Install the MABS main unit in a location described in the figure.



■ The figure to the left show installation position when transfer speed is 60m/min. The installation position depends on transfer speed and weight and size of transferred product. Please take a transfer test to find the right position in advance.

- ③ Install the MABS main units to be combined by securing a space of 5 mm.
- ④ Provide the adjustment margin of approximately 50 mm between the MABS main unit and upstream/downstream conveyors.

About area and zone sensors

Refer to the following instructions, and perform frame processing so that sensors can be mounted.

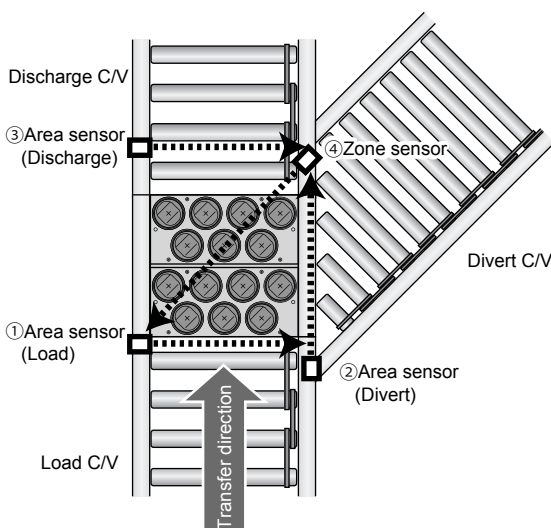

- ① Mount the loading area sensor on the upstream side of the MABS main unit.



■ For position of sensor which is assigned as trigger for ball turning, perform transfer test in advance, and determine after adjusting to the appropriate position.

- ② Mount the area sensor used to check discharging on the diverting side, at the boundary of the straight conveyor and diverting conveyor.
- ③ Mount the area sensor used to check discharging on the straight side, in the most downstream of the diverting section.
- ④ Mount the zone sensor used to check the presence of totes in the diverting section (on the MABS main unit).

Safety precautions

Advance preparation

Product check

Structures

Installation/Wiring

IB-E06F-M1 settings

Control/Operation

Maintenance/Inspection

Troubleshooting

Appendix

7. Installation/Wiring

Dimensions of MABS main unit

Size 400
L186mm×W398mm

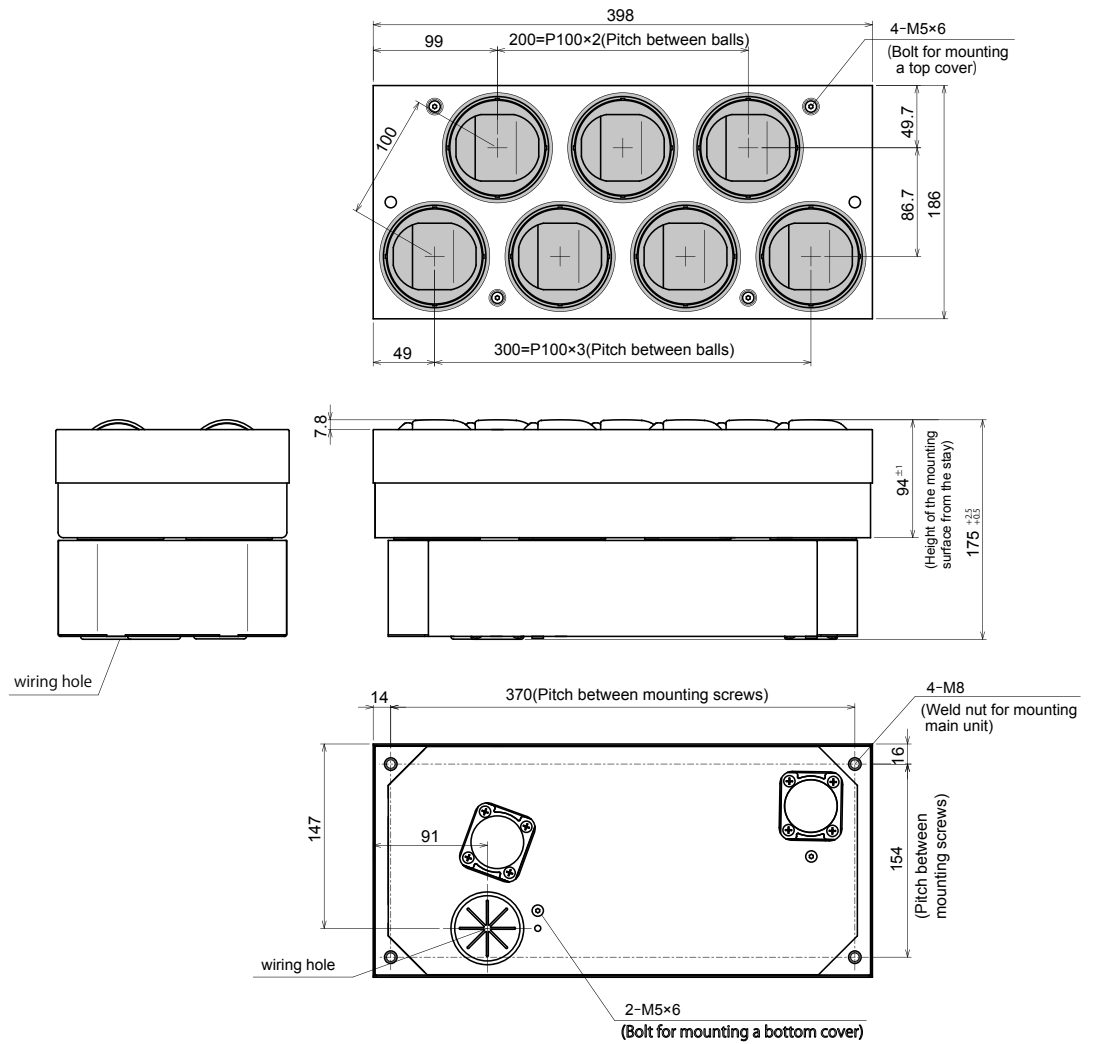

The machine height and height of the mounting surface indicate dimensions at the time of the actual transfer (when load is applied to transfer balls).

※Guide for cable marginal projecting length (mm)

M1 : Motor of Transfer balls	80
M2 : Motor of Swing	80
SA : Proximity sensor (Origin)	80

! ■ The origin sensor cable needs to be extended.

7. Installation/Wiring

Size 500
L186mm×W498mm

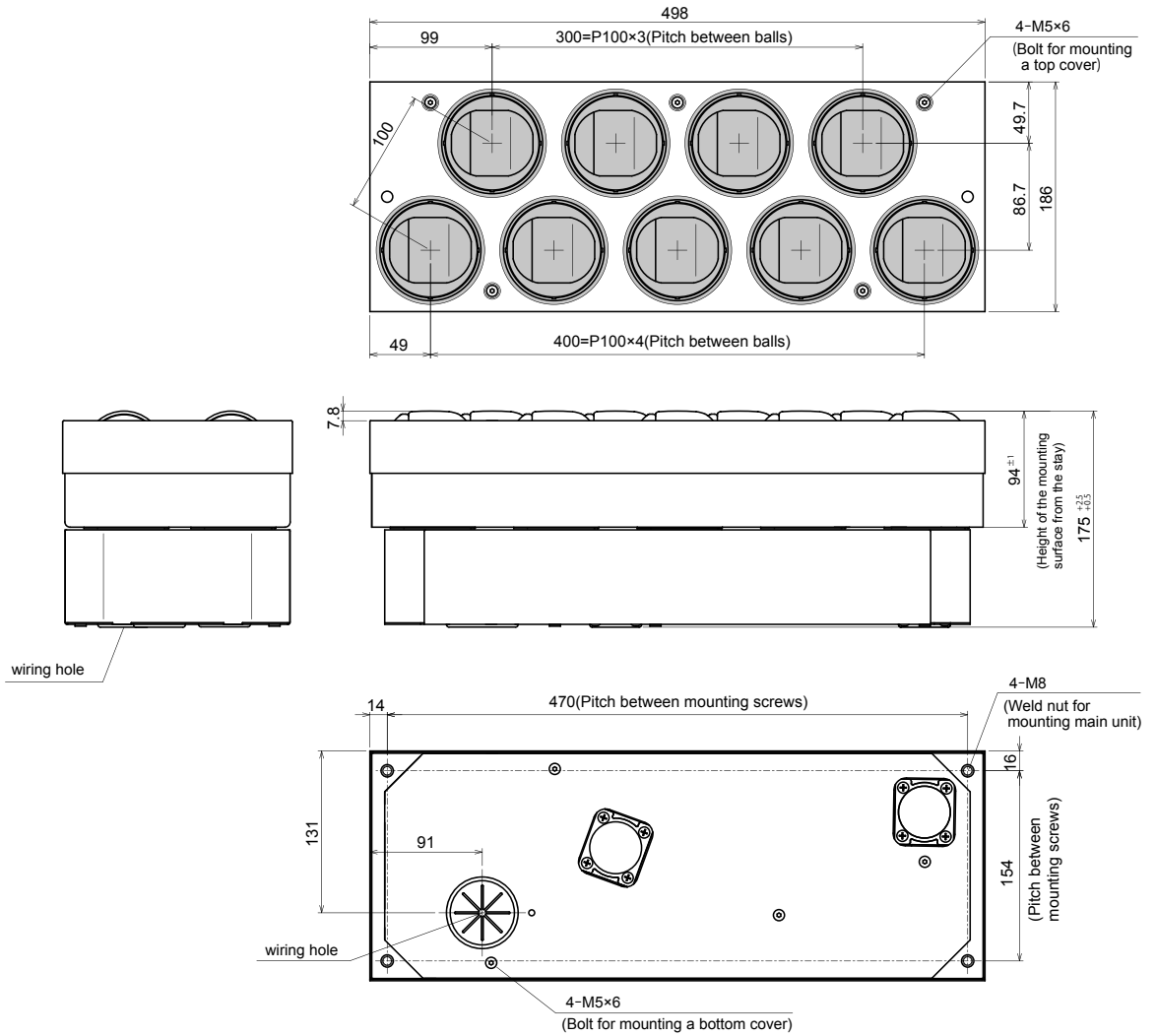

The machine height and height of the mounting surface indicate dimensions at the time of the actual transfer (when load is applied to transfer balls).

※Guide for cable marginal projecting length (mm)

M1 : Motor of Transfer balls	80
M2 : Motor of Swing	80
SA : Proximity sensor (Origin)	80

! The origin sensor cable needs to be extended.

7. Installation/Wiring

Size 600
L186mm×W598mm

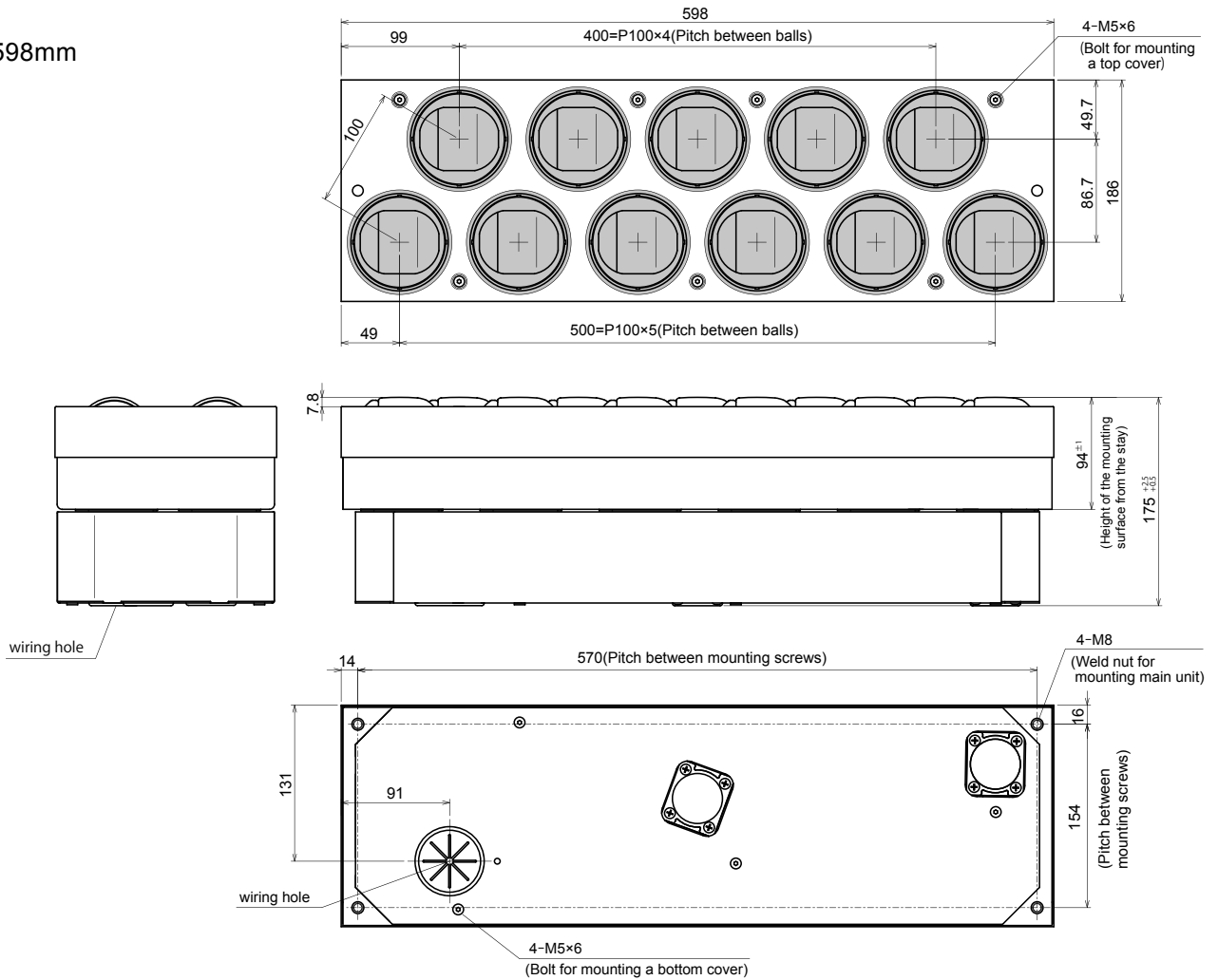

※Guide for cable marginal projecting length (mm)

M1 : Motor of Transfer balls	80
M2 : Motor of Swing	80
SA : Proximity sensor (Origin)	80

The machine height and height of the mounting surface indicate dimensions at the time of the actual transfer (when load is applied to transfer balls).

! The origin sensor cable needs to be extended.

7. Installation/Wiring

Size 700
L186mm×W698mm

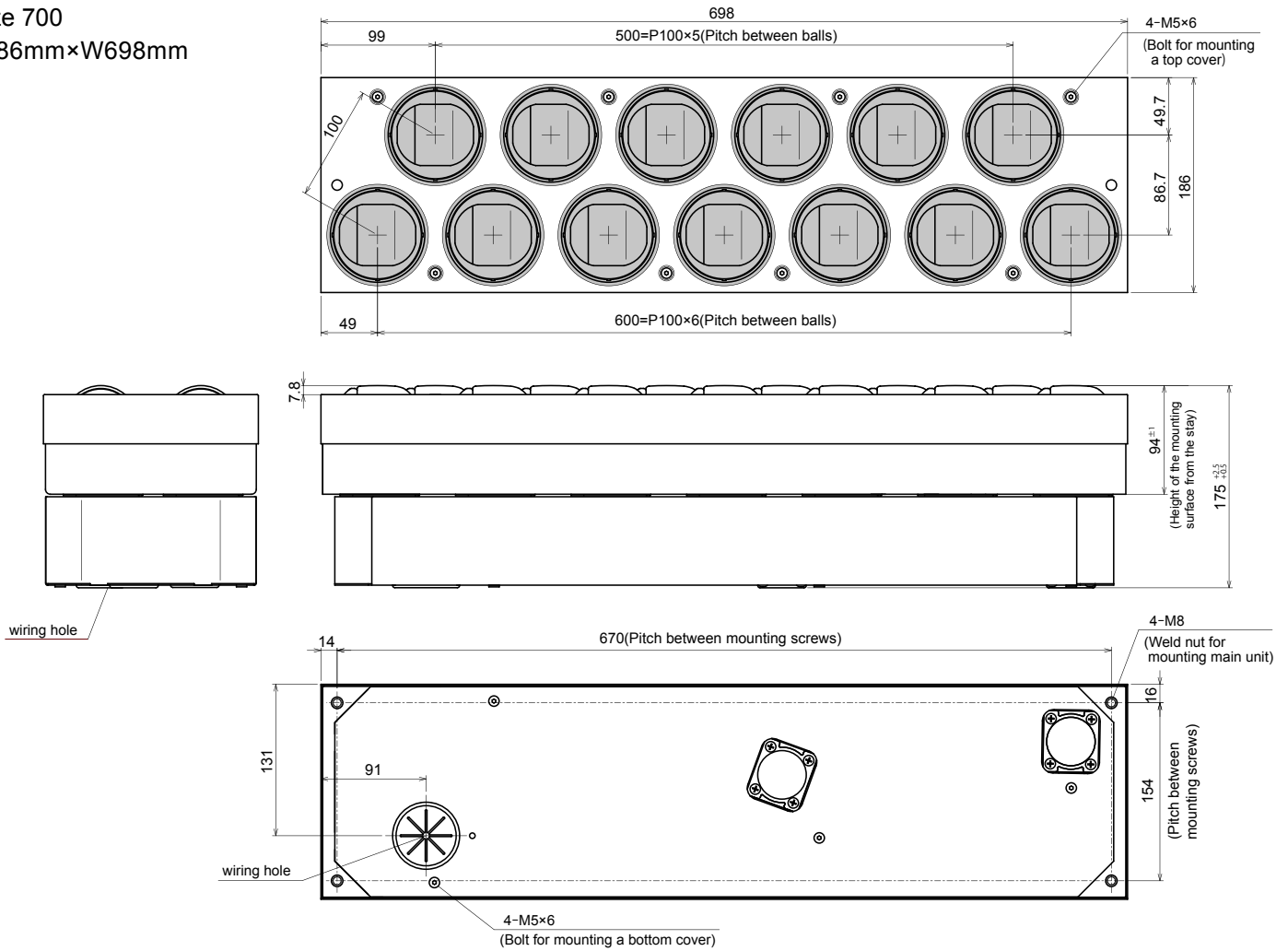

※Guide for cable marginal projecting length (mm)

M1 : Motor of Transfer balls	80
M2 : Motor of Swing	80
SA : Proximity sensor (Origin)	80

The machine height and height of the mounting surface indicate dimensions at the time of the actual transfer (when load is applied to transfer balls).

! The origin sensor cable needs to be extended.

7. Installation/Wiring

Size 800
L186mm×W798mm

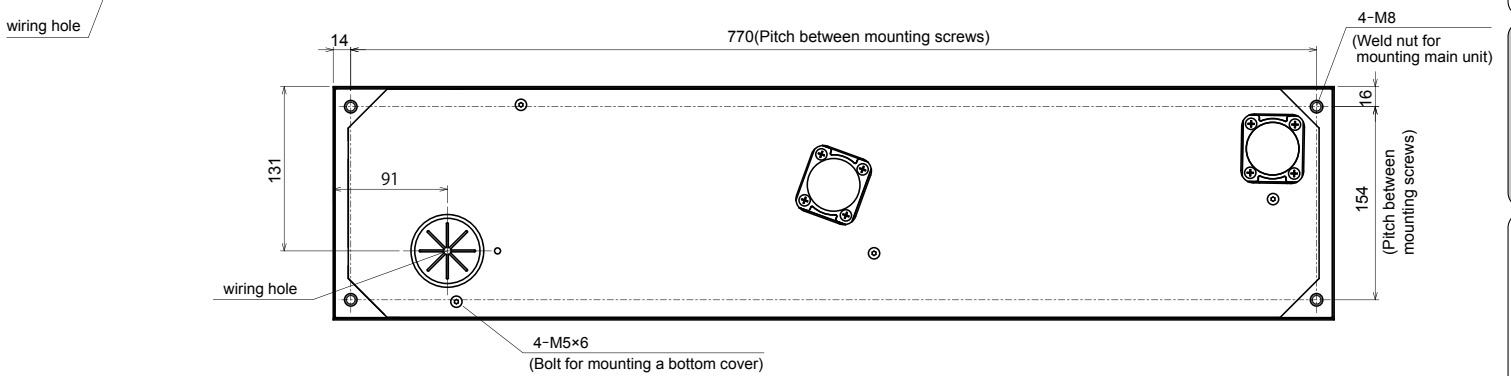
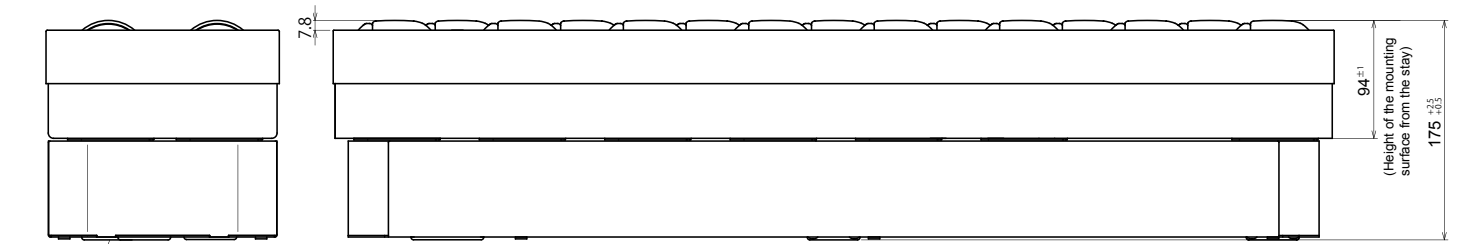
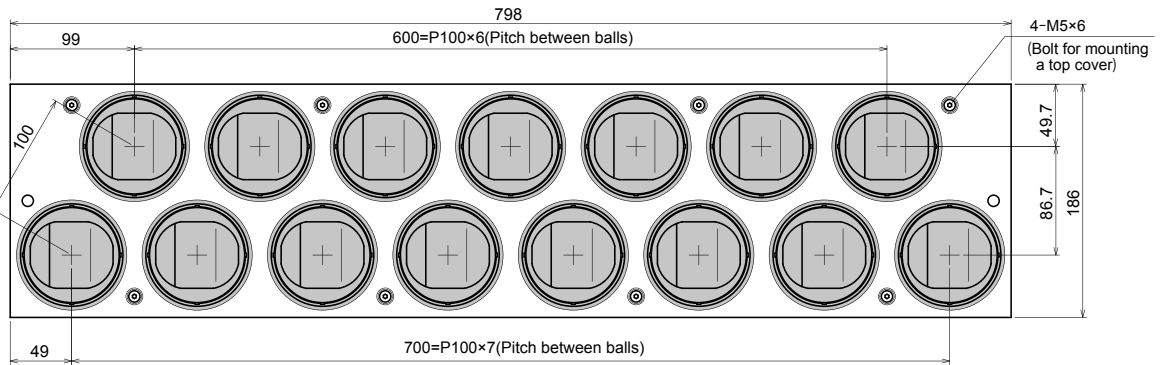

※Guide for cable marginal projecting length (mm)

M1 : Motor of Transfer balls	80
M2 : Motor of Swing	80
SA : Proximity sensor (Origin)	80

The machine height and height of the mounting surface indicate dimensions at the time of the actual transfer (when load is applied to transfer balls).

! The origin sensor cable needs to be extended.

Safety precautions

Advance preparation

Product check

Structures

Installation/Wiring

IB-E06F-M1 settings

Control/Operation

Maintenance/Inspection

Troubleshooting

Appendix

7. Installation/Wiring

Mounting preparation for controller

Mounting hole processing on frames and control panel

- 1**
 - Perform mounting processing on the frames and control panel by reference to the mounting holes for controllers.
 - Cable position of MABS and the cable length from MABS main unit, refer to dimensions of MABS main units(P.25).



- Mount controllers on a flat surface where heat can be released easily.
- Prevent chips generated during processing from entering controllers.

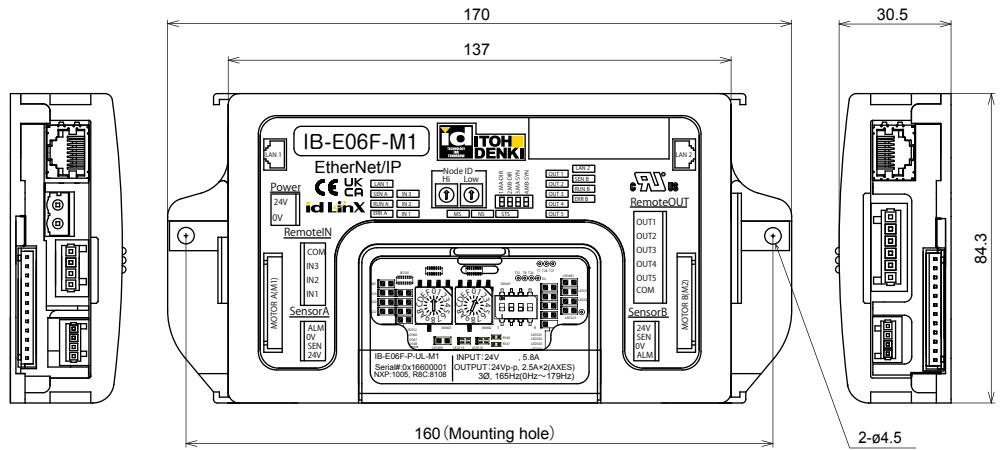

7. Installation/Wiring

7-2. Installation

Installing the MABS main unit

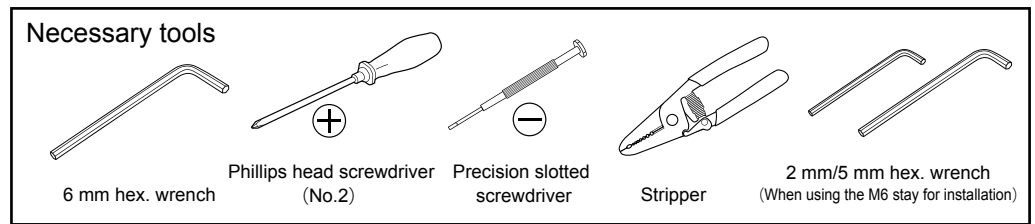

■ Installing the MABS main unit



- When installing the MABS main unit, make sure to use the designated stay. If those other than designated stays have been used, warranty will not be applied.
- The designated stay has two types to be used for M6 and M8. ⇒Refer to P.16

1 Mount stays on conveyor frames.



- For dimensions of the stay, refer to P.16.

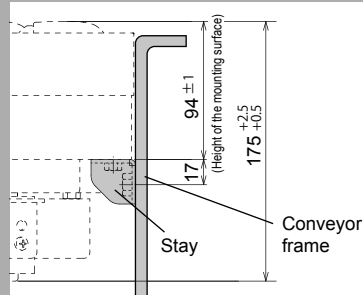

- The mounting method on the conveyor frames and mounting parts are common to stays (M6) and (M8).
- Recommended tightening torque: 12 to 14 N·m

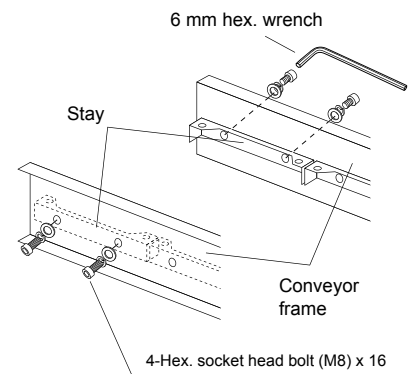

2 Carry this product to the installing location.



- When lifting, hold the bottom cover of the main unit.

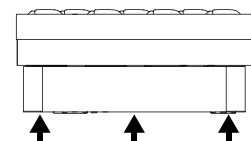

Hold the bottom cover

3 Turn the row of less transfer balls to the upstream side, and place on the stays.



- When installing, be careful not to get fingers caught.
- Install this product in places with a mounting surface tilt (inclination) of 0.5% or less.
- Install in locations where the weight of this product and totes can be sufficiently supported. (For the main unit weight, refer to P.72)
- The vibration level in the installation environment for this product should be 0.5G or less.
- Observe safety regulations required for installation locations or equipment in use.

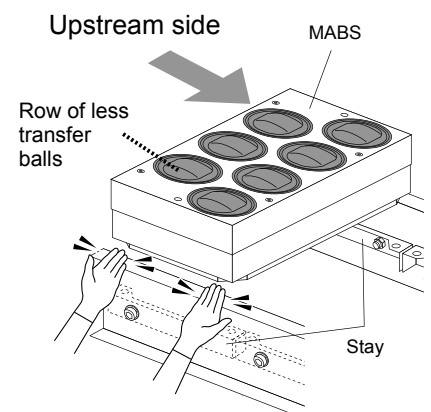

7. Installation/Wiring

4 Fasten the MABS main unit and stays.

When using stays for installation
(For stays (M6))

When using stays (M6)

Remove the top cover, and fasten from the top at four positions using M6 bolts.



- Mounting bolt
Hex. bolt with spring lock and plain washers (M6) x 25
- Recommended tightening torque
10 to 12N·m

Mount the top cover.



- Recommended tightening torque
3.2N·m

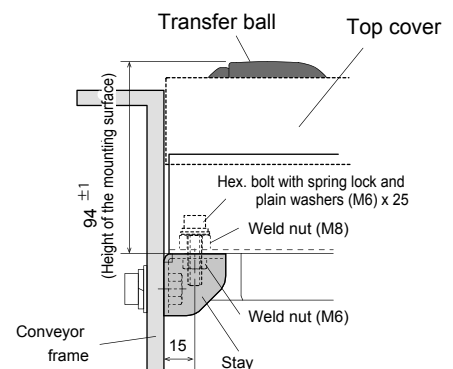
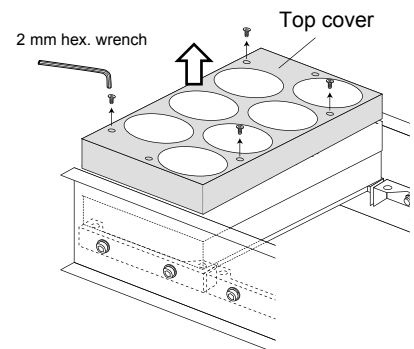

When using stays for installation
(For stays (M8))

When using stays (M8)

Fasten from the bottom at four positions using M8 bolts.



- Mounting bolt
Hex. bolt with spring lock and plain washers (M8) x 20
- Recommended tightening torque
12 to 14N·m

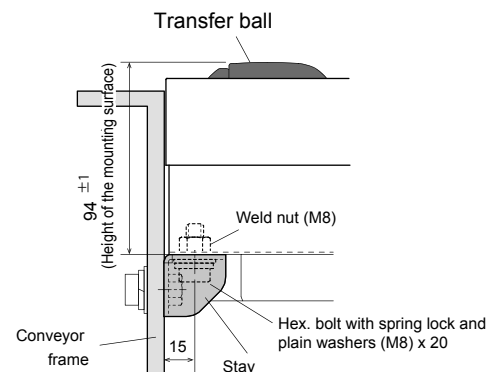
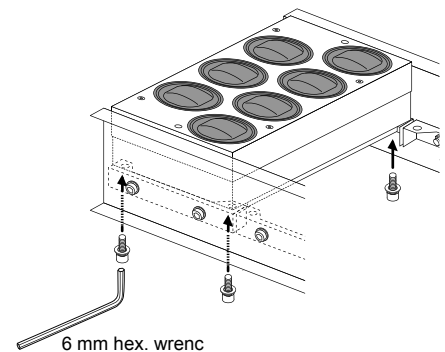

5 Adjust the conveyor frame legs on which the MABS main unit has been mounted, and align levels of the MABS main unit and the adjacent conveyor.

7. Installation/Wiring

Mounting the controller

Mounting the controller

Use the included screws and nuts to mount controllers on the conveyor frames or control panel.



■ Recommended tightening torque
0.74N·m

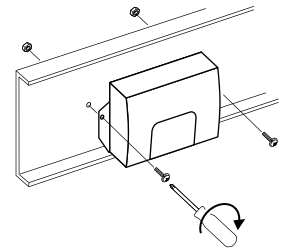

Mounting sensors, control devices, and power supply units

Mounting sensors, control devices, and power supply units

Mount customer-prepared zone sensor and area sensor for loading and discharging, as well as control devices, such as PLCs, and power supply units.

7-3.

Wiring

Connecting MABS main unit and controller

Connecting MABS main unit and controller

- 1 Take out a proximity sensor cable for origin position, motor cables for transfer (M1) and swing (M2) from the wiring hole.

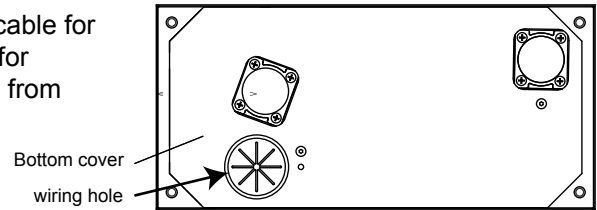

- 2 Refer to the labels for cables coming from the MABS main unit, and securely connect the motor connectors and extension cables to the controller.

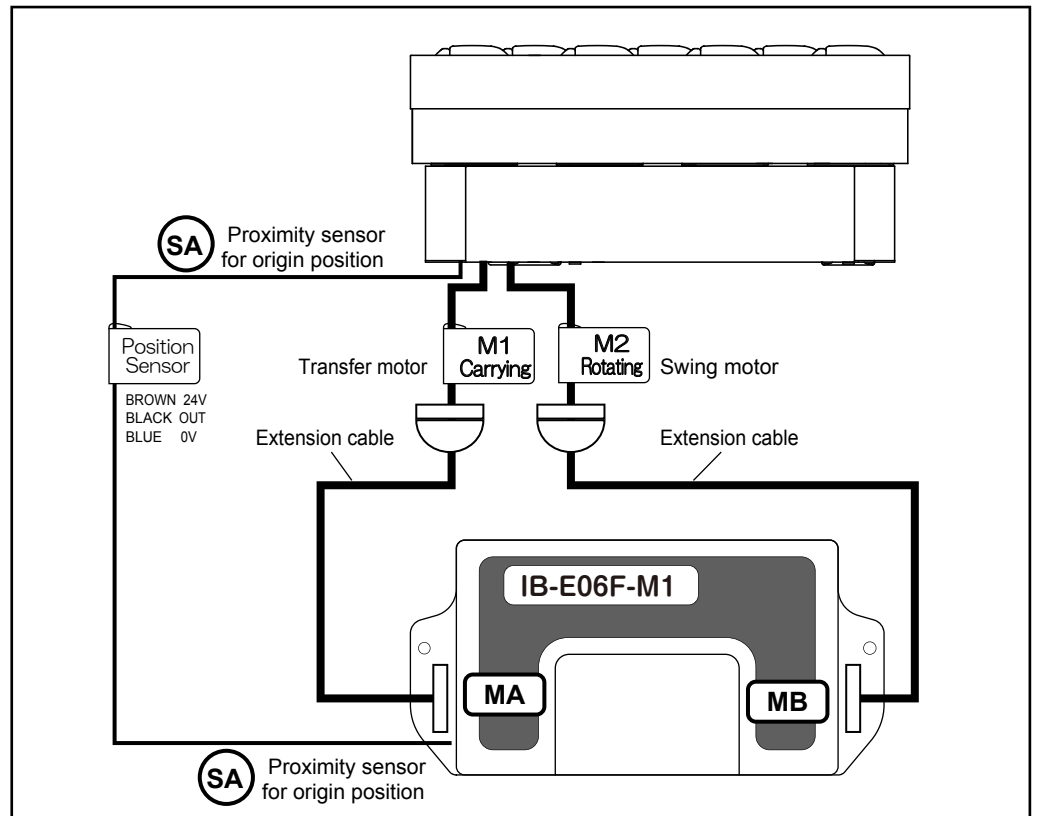

7. Installation/Wiring

Reference of wiring

Term

Master unit
A MABS unit to operate through signal communications with PLCs.

Synchronized unit
A MABS unit to operate by receiving signals from the master unit

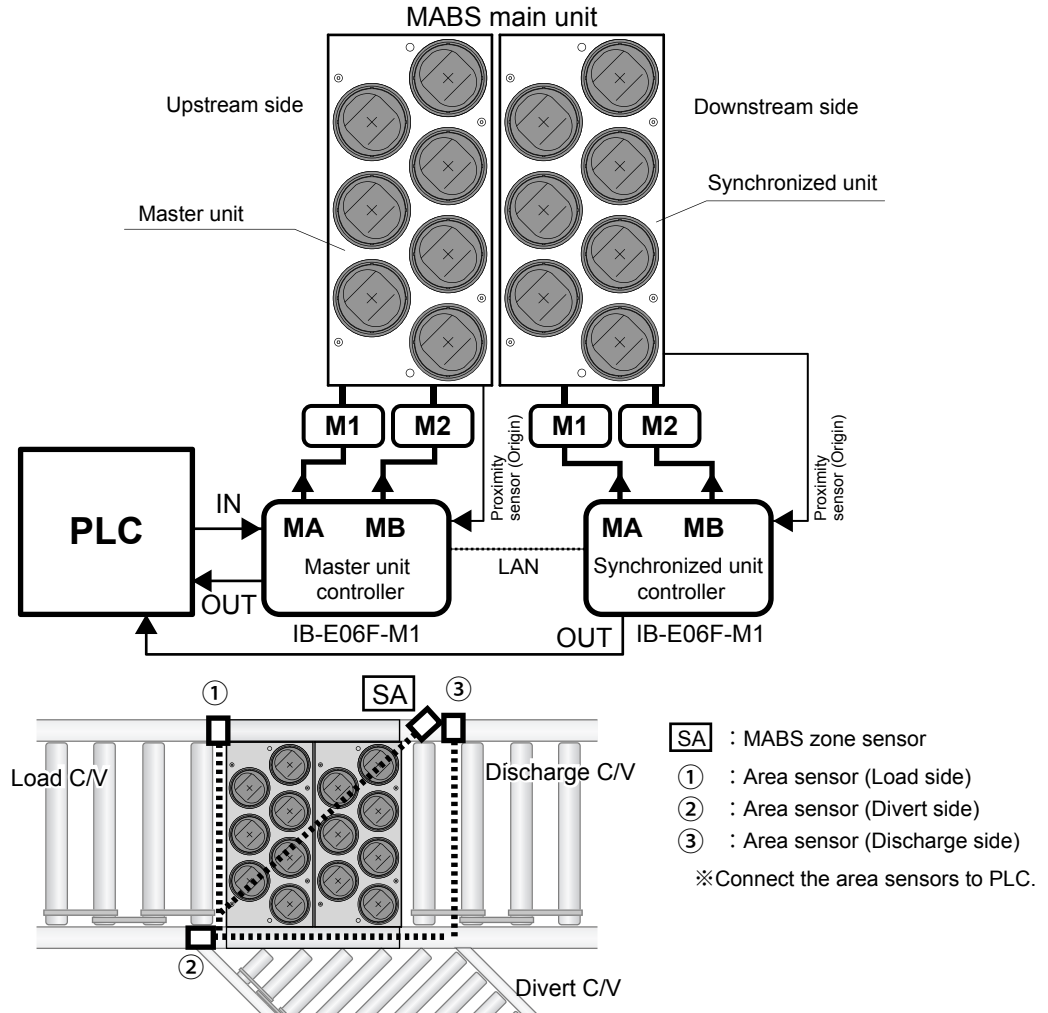

※When each unit set as master unit, each MABS unit can also be operated individually using the signal input/output from PLC.

Wiring Diagram

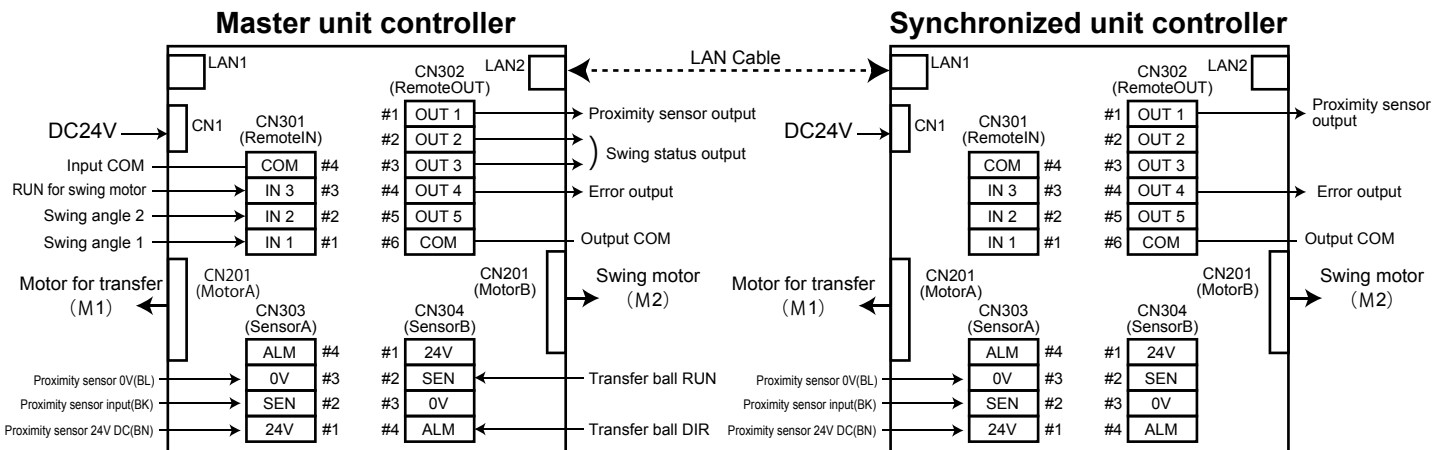

- When using multiple power supply units, 0V of PLC and 0V of controller to be common. Failure to follow this could result in operation failure.
- Make sure to perform wiring so that the most upstream unit is set to be the master unit controller. Also, perform wiring so that units other than the above are set to be the synchronized unit controllers.
- Wire signals from PLC into only master unit.

7. Installation/Wiring

I/O settings

		I/O	Description	Details
CN201		Motor A	For transfer	M1: Carrying (Labeled on motor cable)
		Motor B	For Swing	M2: Rotating (Labeled on motor cable)
CN303	#2	Sensor A SEN	Proximity sensor input for origin position.	Proximity sensor (Origin position: Prox. Sensor ON for straight direction)
CN304	#2	Sensor B SEN	Transfer ball RUN	Input to run transfer balls (Transfer from upstream to downstream)
	#4	Sensor B ALM	Transfer ball DIR	Input to switch the rotation direction of transfer balls
CN301	#1	RemoteIN1	Specified swing direction	Input to determine the swing direction (Angle is determined by number of motor pulse)
	#2	RemoteIN2		
	#3	RemoteIN3	RUN for swing motor.	Input to start swinging. After inputting the specified swing direction, wait for 20 msec or more until RUN for swing motor is input.
	#4	COM	Input COM	—
CN302	#1	RemoteOUT1	Proximity sensor output	Output proximity sensor signal that connected into own unit. Turn ON to straight direction (Origin position).
	#2	RemoteOUT2	Swing status output	Outputs the current swing status. • When all units have no delay setting: Outputs the swing status after swing is completed in all units. • When at least one unit has the delay setting: Outputs the swing status after own unit completes swing.
	#3	RemoteOUT3		
	#4	RemoteOUT4	Error output	Outputs the error status of the unit. (Outputs only an error of the own unit.)
	#6	COM	Output COM	—

Specified swing direction

Swing	RemoteIN1	RemoteIN2
Divert direction to Straight direction (CW direction)	ON	ON
Divert direction to Straight direction (CCW direction)	OFF	OFF
Straight direction to Divert direction (CW direction)	ON	OFF
Straight direction to Divert direction (CCW direction)	OFF	ON

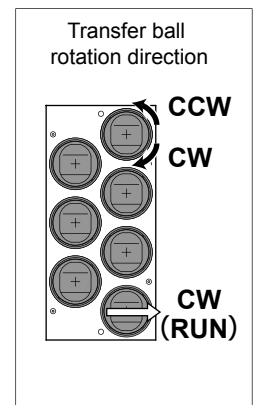

Start Swinging

Swing	RemoteIN3
STOP	OFF
RUN	ON

※Automatically stops when balls have been rotated to the specified angle.

Swing status output

Swing status	RemoteOUT2	RemoteOUT3	Remarks
Straight (origin)	ON	ON	Outputs at the time when balls have been turned to the straight direction.
Swing (CW)	ON	OFF	Outputs at the time when swing in CW direction is complete.
Swing (CCW)	OFF	ON	Outputs at the time when swing in CCW direction is complete.
Others	OFF	OFF	During ball swing, when turning on power supply, undetected swing position or occurring software error.

Safety precautions

Advance preparation

Product check

Structures

Installation/Wiring

IB-E06F-M1 settings

Control/Operation

Maintenance/Inspection

Troubleshooting

Appendix

7. Installation/Wiring

IB-E06F-M1

IB-E06F-M1 wiring

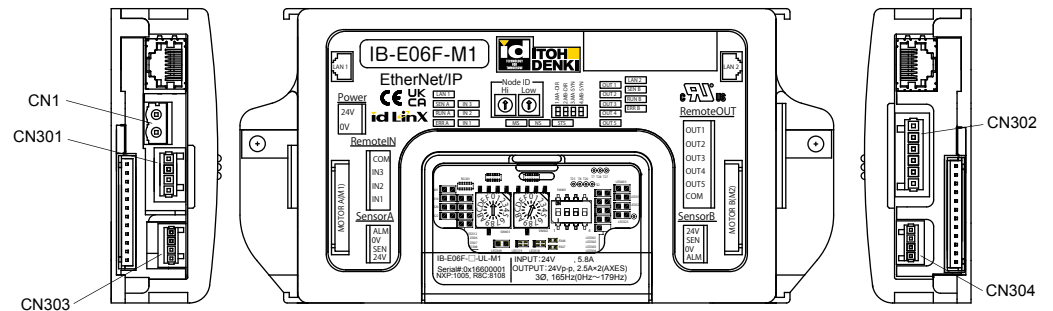

CN1 : Power connector



CN303/CN304 Sensor connector



CN301 : Remote input connector

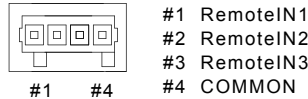

CN302 : Remote output connector

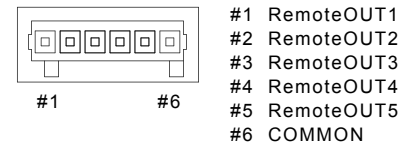

CN1:
Power connector

1 Connect the 24V DC and 0V DC cables to CN1 (2 pins).



- Do not connect multiple power cables to one pin. Failure to follow this could result in electric shock, short circuit, and/or damage due to the capacity of connectors being exceeded. (Connector capacity: 16 A)
- Do not connect the 24V DC and 0V DC cables incorrectly.
- Do not connect cables when connectors are plugged in.

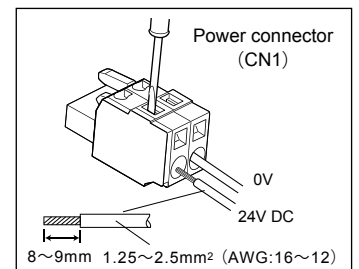

CN301 ~ CN304 :
Remote input/
Remote output/
Sensor connector

2 Connect input/output cables to each connector.

※Refer to P.36, and perform wiring according to operation.

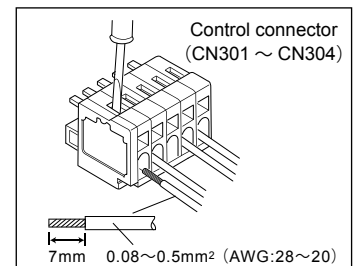

Connecting to controllers

3 Connect the power connector (CN1) and control connector (CN301 - CN304) to controllers.

7. Installation/Wiring

Input/output circuit

! ■ Connect the COMMON terminal for remote input and remote output separately.

CN301

[Remote input (CN301)] 734-264 (WAGO) Maximum allowable current:10[A]

- Set the NPN/PNP signal switching for remote input using COMMON.
Connect the positive pole to COMMON at the time of NPN input, and 0V to COMMON at the time of PNP input.
COMMON is common among RemoteIN1 to 3.

Remote input interface circuit diagram

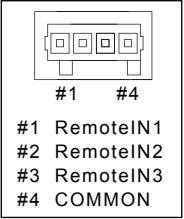
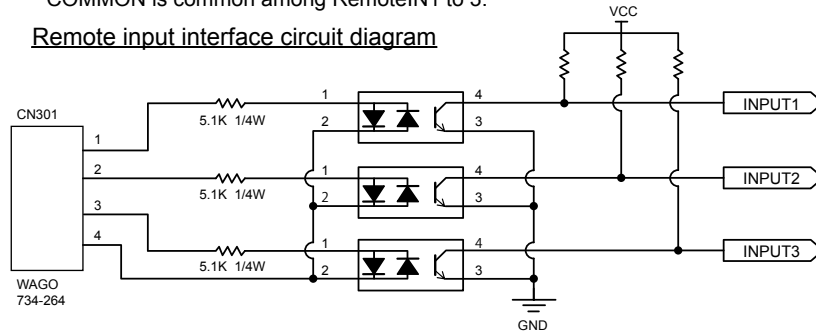

! ■ Set the voltage used for remote input within the range of 18 [V]DC to 30 [V]DC.

CN302

[Remote output (CN302)] 734-266 (WAGO)

- Set the NPN/PNP signal switching for remote output using COMMON.
Connect 0V to COMMON at the time of NPN output, and the positive pole to COMMON at the time of PNP output.
Note that COMMON is common among RemoteOUT1 to 5.

Remote output interface circuit diagram

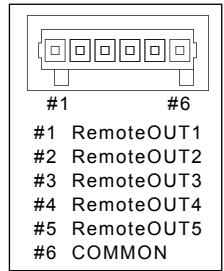
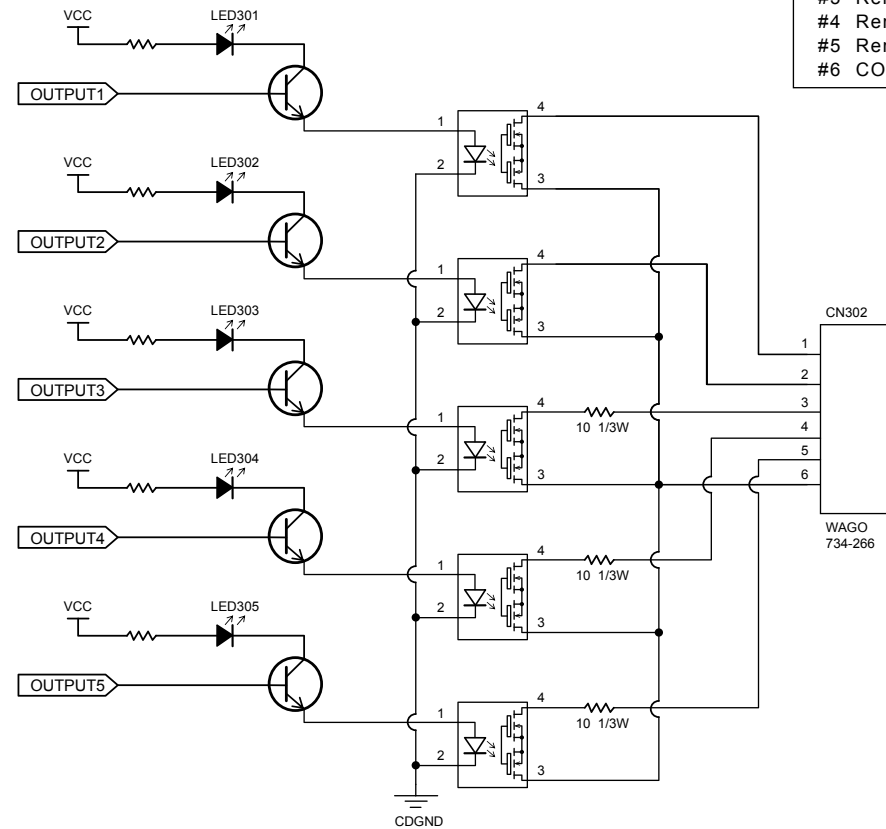

! ■ Set the voltage used for remote output within the range of 18 [V]DC to 30 [V]DC.
 ■ The maximum output current value for remote output is 1 [A] on #1 and #2, and 200 [mA] on #3 to #5.
 ■ When outputting the remote output to the relay coil, use surge protector devices, or perform surge protection measures using diodes.
 Failure to perform surge protection measures could result in damage to the signal output terminal, if counter electromotive voltage is generated when switching the output signal.

Safety precautions
 Advance preparation
 Product check
 Structures
 Installation/Wiring
 IB-E06F-M1 settings
 Control/Operation
 Maintenance/Inspection
 Troubleshooting
 Appendix

8. IB-E06F-M1 settings

- 8-1. Setting preparation 40
- 8-2. Property settings 43

8. IB-E06F-M1 settings

Flow of settings

IB-E06F-M1 controls the MABS using the property setting and ladder logic. This section explains the setting preparation and property settings.

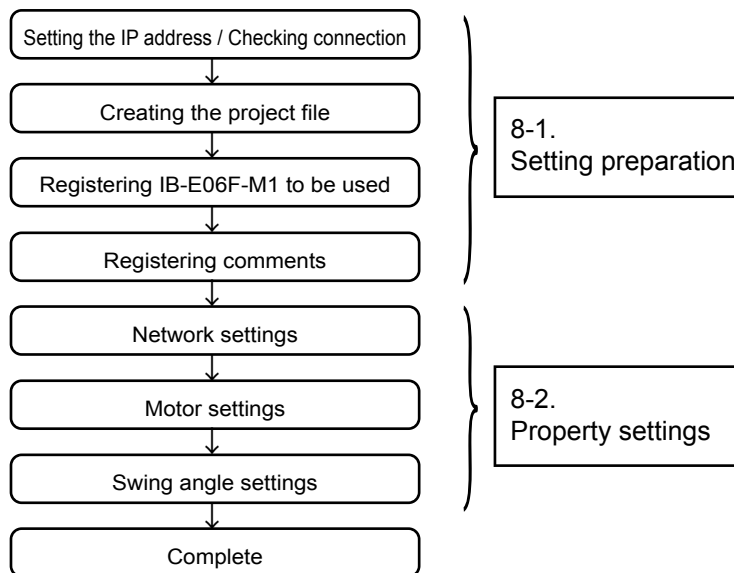

8. IB-E06F-M1 settings

8-1. Setting preparation

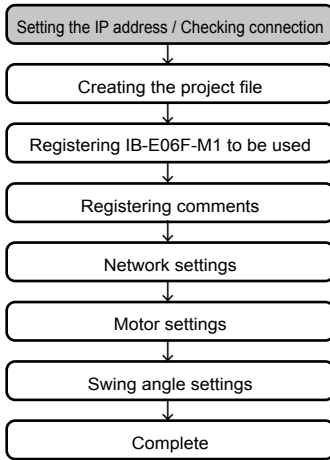

Setting the IP address / Checking connection

1 Make sure that all DIP switches of SW401 on IB-E06F-M1 are turned OFF.

! All switches are OFF under the factory settings. Do not change.

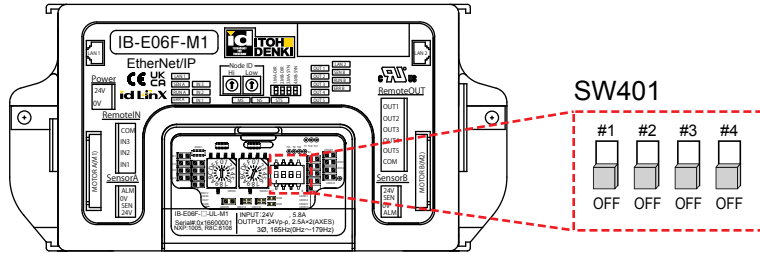

2 "192.168.1.1 / 255.255.255.0" has been set under the IB-E06F-M1 factory settings. Change the "xxx" part of the IP address "192.168.1.xxx" using the IB rotary switches SW402 and SW403.

Set the IP address in hexadecimal.

Example)

SW403	SW402	Numerical value [※]
0	2	2
0	A	10
1	0	16
1	F	31

[※]Indicates "xxx" for "192.168.1.xxx".

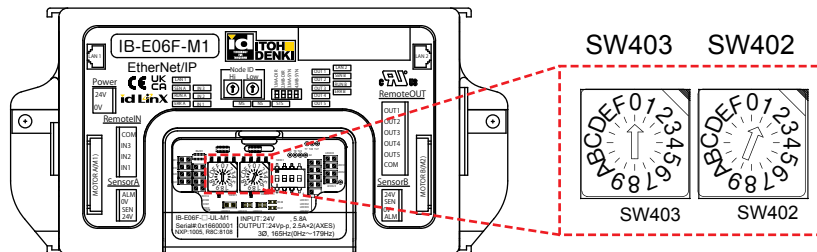

! Set the IP address to avoid overlapping. Do not turn controller switches with excessive force.

3 Connect the IB-E06F-M1 using the LAN cable, and turn on the power to it.

4 Set the IP address for the PC to "192.168.1.XXX / 255.255.255.0" (same network).

1 Open "Control Panel" - "Network and Sharing Center", and click "Local Area Connection"

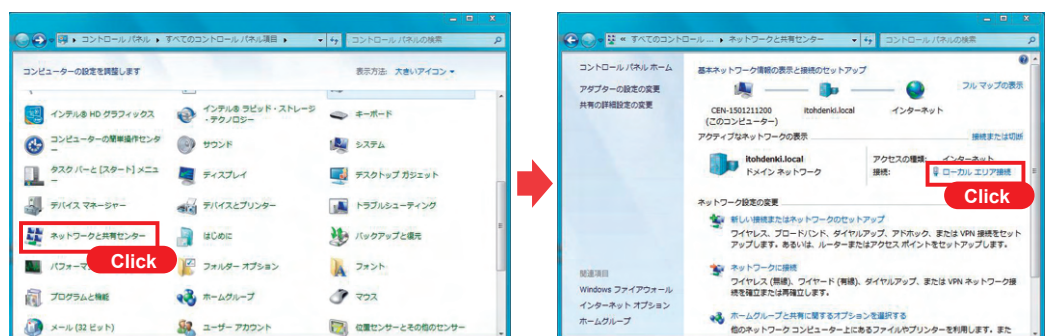

8. IB-E06F-M1 settings

- Open "Properties", and select "Internet Protocol Version4 (TCP/IPv4)". Click "Properties"

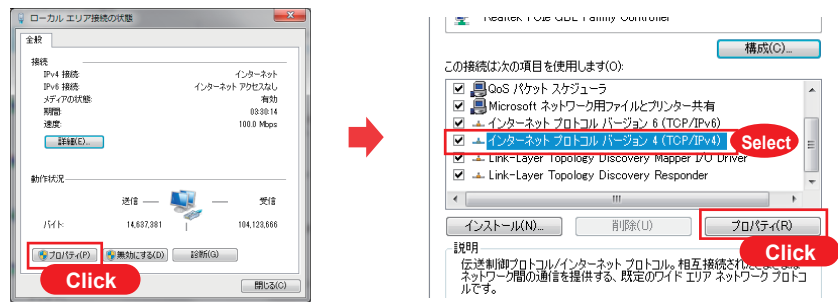

- Set the IP address to "192.168.1.XXX", and Subnet mask to "255.255.255.0". Click "OK".

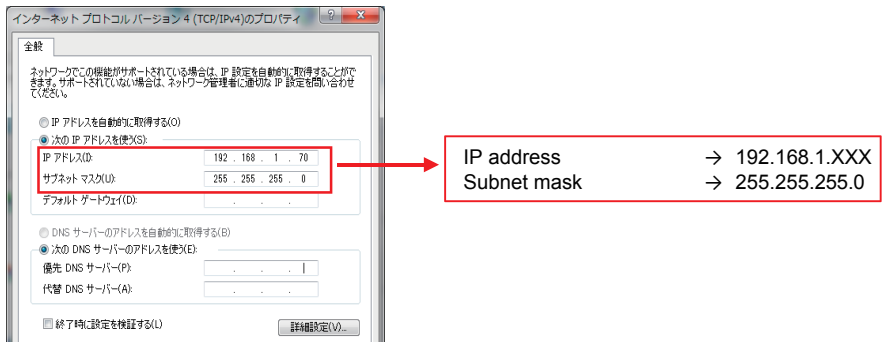

! Set the IP address to avoid overlapping with other addresses for IB-E06F-M1, etc.

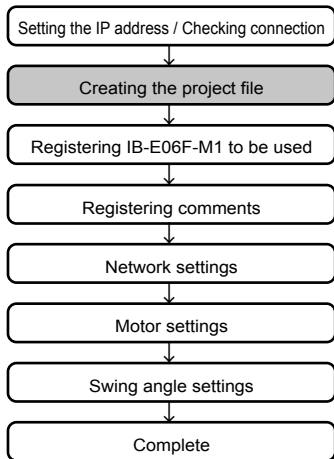

Creating the project file

- Start iCEP Lite, and create the project file.

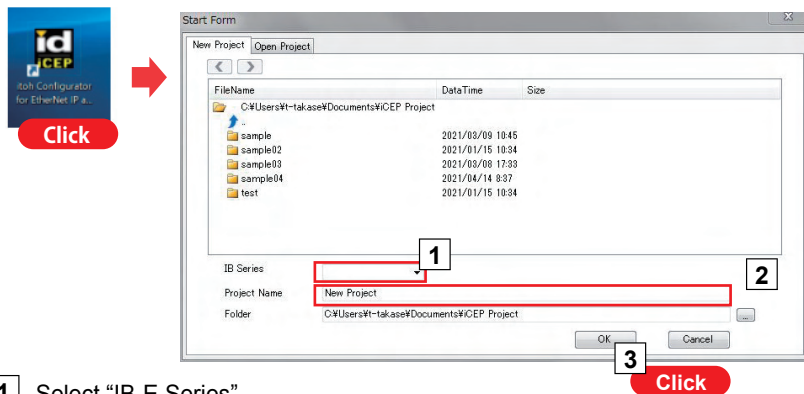

- Select "IB-E Series"
- Register the file name
- Click "OK"

8. IB-E06F-M1 settings

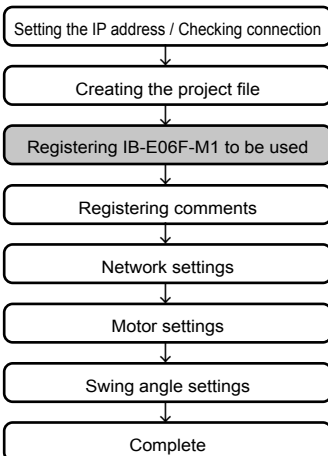

Registering IB-E06F-M1 to be used

Before executing operations, such as writing the property settings to IB-E06F-M1, IB-E06F-M1 to be used needs to be registered in the project.

- 1 Expand the project management from the project tree window, right-click “Device”, and click “Add”.

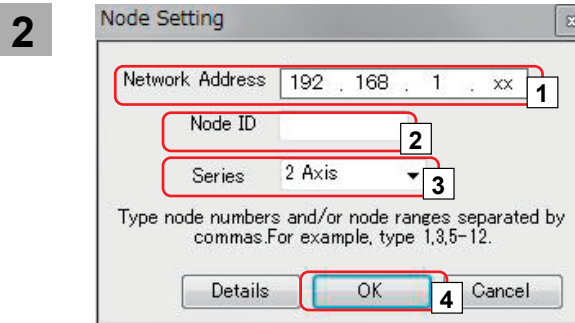
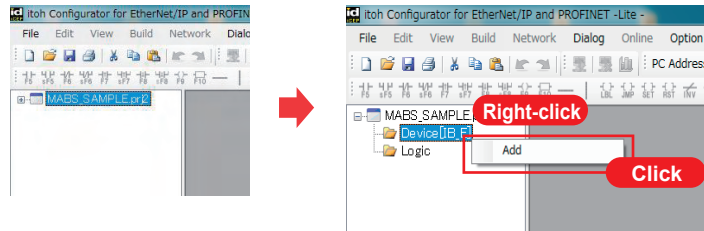

- 1 Enter “192.168.1” of the IB-E06F-M1 network address “192.168.1.xxx”.
- 2 Enter the NodeID of IB-E06F-M1 that operates simultaneously.



■ The NodeID is the IP address value specified by SW402 and SW403 on IB-E06F-M1.

Example) When registering NodeID “1 to 3”, enter “1-3” or “1,2,3”.

Example) When registering NodeID “1, 3”, enter “1,3”.

- 3 Select “2 Axis”.
- 4 Click “OK”.

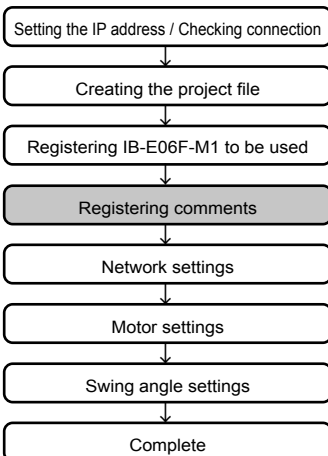

Registering comments

- 1 Select “Logic” directly under the project file name in the project tree window.

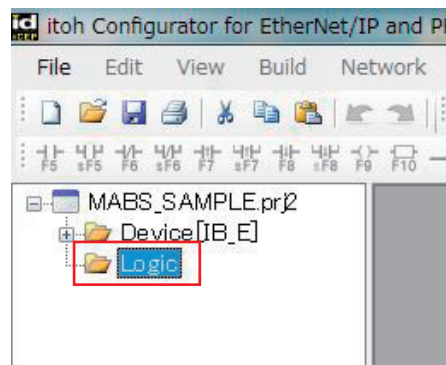

Project tree window

8. IB-E06F-M1 settings

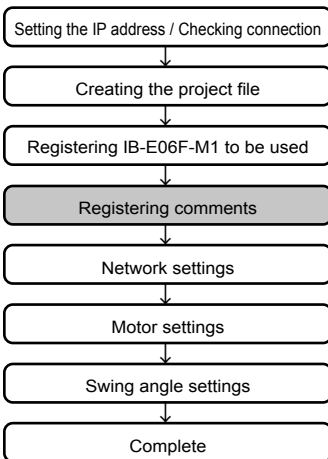

- 2** Right-click and select “Import” to import the comment file.

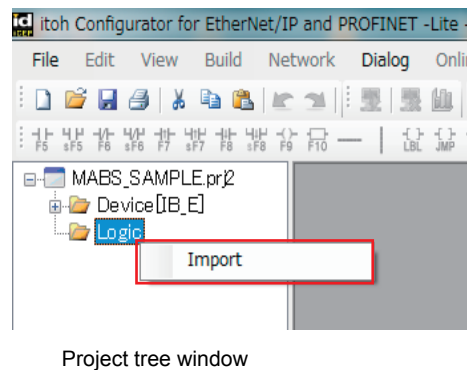

Project tree window



End of setting preparation.

8-2. Property settings

IB-E06F-M1 property settings

In the property settings, set the MABS transfer speed to be written to IB-E06F-M1.



Perform the property settings for both the master unit controller and synchronized unit controller.

- 1** Expand “Device” on the project tree window, and display the IP address for the corresponding IB-E06F-M1.
- 2** Double-click “Property” to open the property setting window.

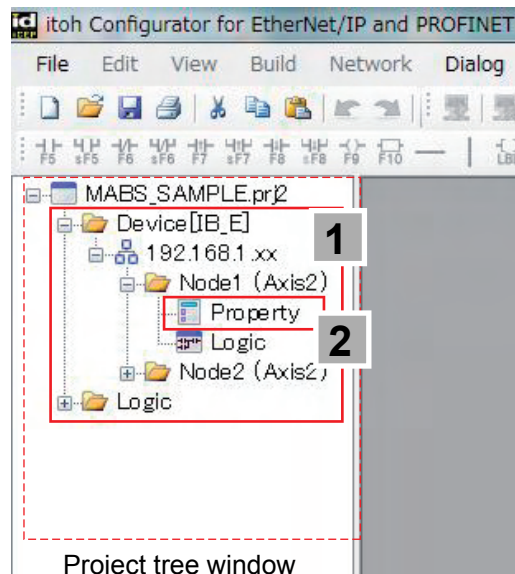

Project tree window

8. IB-E06F-M1 settings

Property setting window

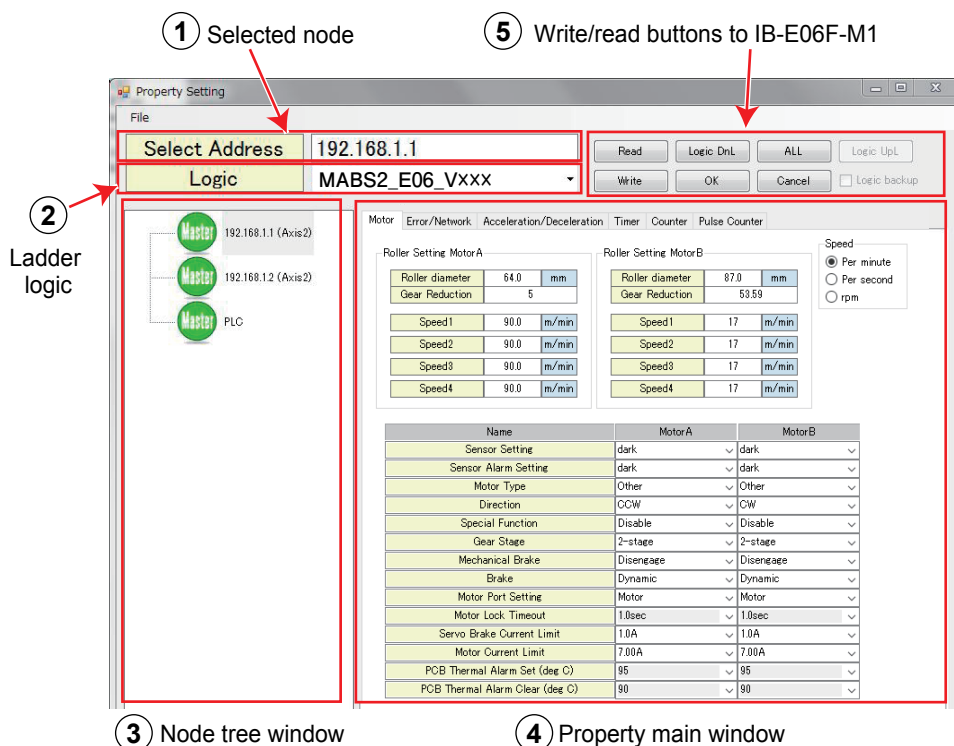

- ① Selected node
The IP address for the IB-E06F-M1 of for which the properties are being specified is displayed. Double-click the node on the “③ Node tree window” to switch the selected node.
- ② Ladder logic
Select the ladder logic.
- ③ Node tree window
The IB-E06F-M1 registered in the project is displayed. Double-click the node to switch “① Selected node”.
- ④ Property main window

Motor	Settings related to motor control
Error/Network	Settings for error release and Network setting
Acceleration/Deceleration	Motor acceleration / deceleration settings
Timer	Ladder logic timer value settings
Counter	Ladder logic counter value settings
Pulse counter	Swing angle settings

- ⑤ Write/read buttons to IB-E06F-M1
- | | |
|-----------|--|
| Read | Reads the property settings from IB-E06F-M1 |
| Write | Writes the property settings to IB-E06F-M1. |
| Logic DnL | Writes the ladder logic to IB-E06F-M1. |
| ALL | Writes the ladder logic and property settings for all controllers registered in the project. |
| OK | Maintains the changed property settings, and closes the property settings. |
| Cancel | Without maintaining the changed property settings, closes the property settings. |

Safety precautions

Advance preparation

Product check

Structures

Installation/Wiring

IB-E06F-M1 settings

Control/Operation

Maintenance/Inspection

Troubleshooting

Appendix

8. IB-E06F-M1 settings

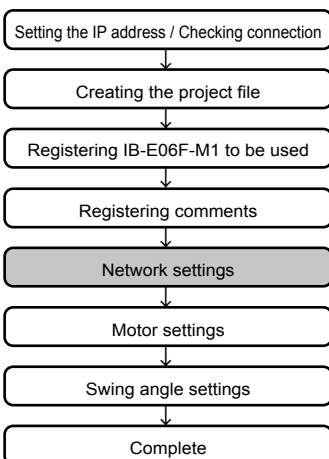

Master unit
Network settings

Network settings

1 Make sure that all the master unit controllers and synchronized unit controllers for the registered IB-E06F-M1 have been set to Master. If any have been set to Slave, select the appropriate node, and right-click to set to Master. (The default value is Master for all controllers.)

! When using only one unit, or operating MABS units individually without connecting each unit using the LAN cable, the Network settings are not necessary.

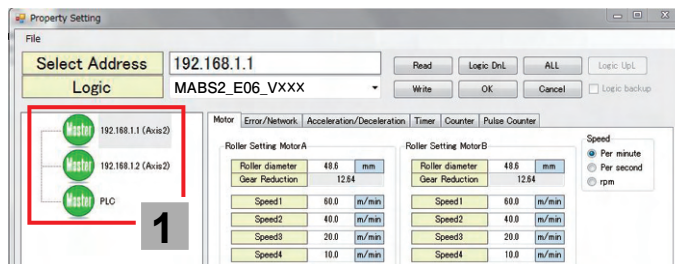

- 2**
- 1** Double-click the master unit.
 - 2** Select "MABS2_E06_Vxxx" for the logic.
 - 3** Select the Error/Network tab.
 - 4** Put a checkmark in Multicast.
 - 5** Enter the address for the unit to be synchronized in Receive node. (If the IP address for the synchronized unit is "192.168.1.xxx", enter "225.0.1.xxx" in Receive node.) When using multiple synchronized units, enter the address for the respective node.

! The following figure indicates an entry example when the synchronized unit is set to Node 2.

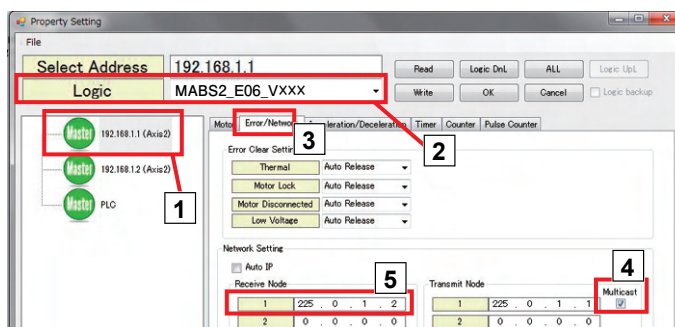

Synchronized unit
Network settings.

- 3**
- 1** Double-click the synchronized unit.
 - 2** Select "MABS2_E06_Vxxx" for the logic.
 - 3** Select the Error/Network tab.
 - 4** Put a checkmark in Multicast.
 - 5** Enter the address for the master unit in Receive node. (If the IP address for the master unit is "192.168. 1.1", enter "225.0. 1.1" in Receive node)

! The following figure indicates an entry example when the master unit is set to Node 1.

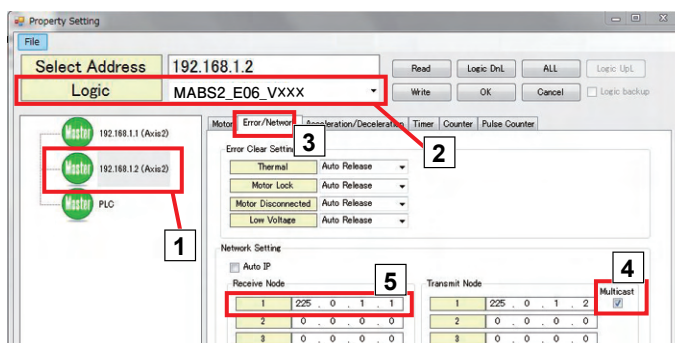

Safety precautions

Advance preparation

Product check

Structures

Installation/Wiring

IB-E06F-M1 settings

Control/Operation

Maintenance/Inspection

Troubleshooting

Appendix

8. IB-E06F-M1 settings

Write

4 Click "Write".

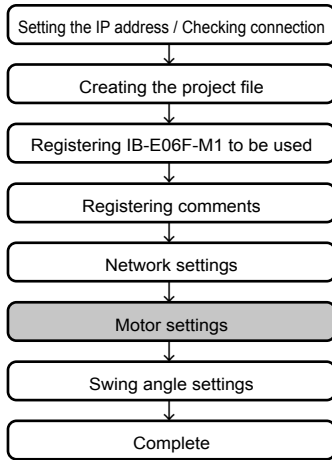
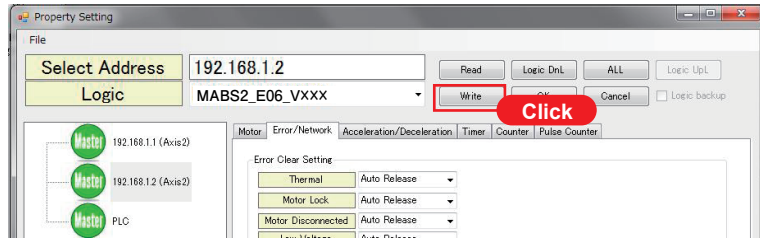

Motor settings

Perform the motor settings.

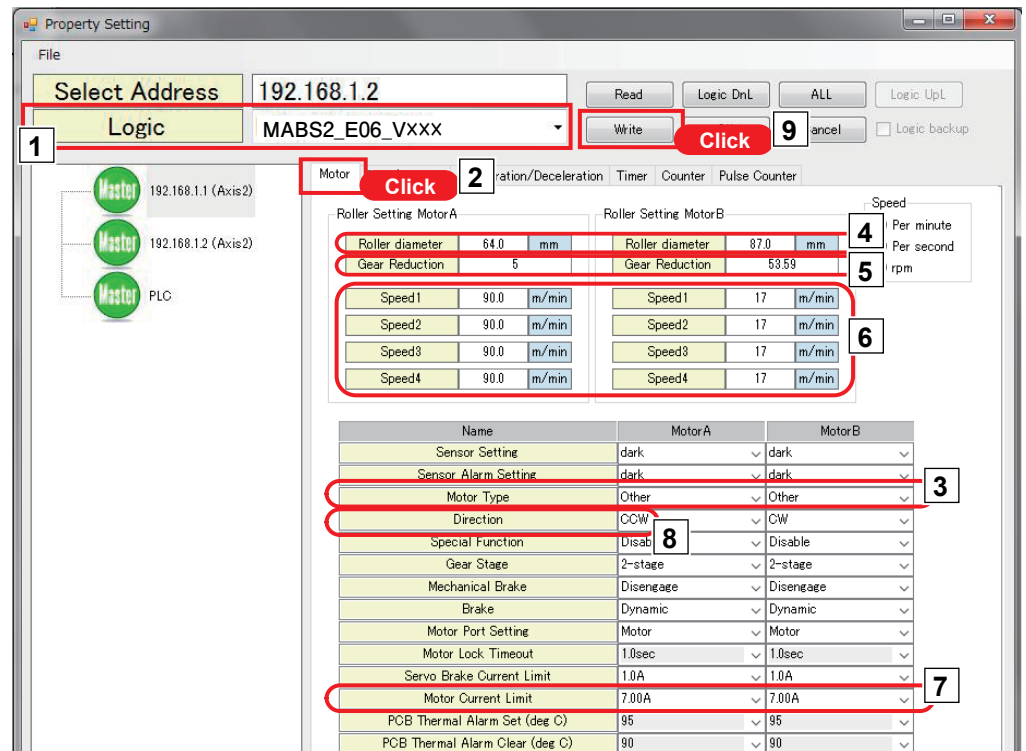

- 1 Select "MABS2_E06_Vxxx" for the logic.
- 2 Select the motor tab.
- 3 Set the motor type to "Other".
- 4 Set the roller diameter to "64.0" for Motor A, and "87.0" for Motor B.
- 5 Set the gear reduction to "5" for Motor A, and "53.59" for Motor B.
- 6 Set the speed 1 to 4 to "90.0"※ for Motor A, and "17.0" for Motor B.
- 7 Set the motor current limitation to "7.00A" for both Motor A and Motor B.
- 8 Set the motor A for rotation direction switching to "CCW".
- 9 Click "Write".

※Indicates the transfer speed. Enter the value within the range of between 30 and 90 m/min.

! Perform the above settings for both master and synchronized units.

☞ Other settings will be automatically specified.

Safety precautions
Advance preparation
Product check
Structures
Installation/Wiring
IB-E06F-M1 settings
Control/Operation
Maintenance/Inspection
Troubleshooting
Appendix

8. IB-E06F-M1 settings

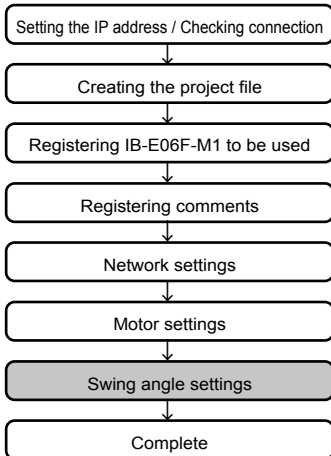

Swing angle settings

Adjust the swing angle using the pulse counter setting.

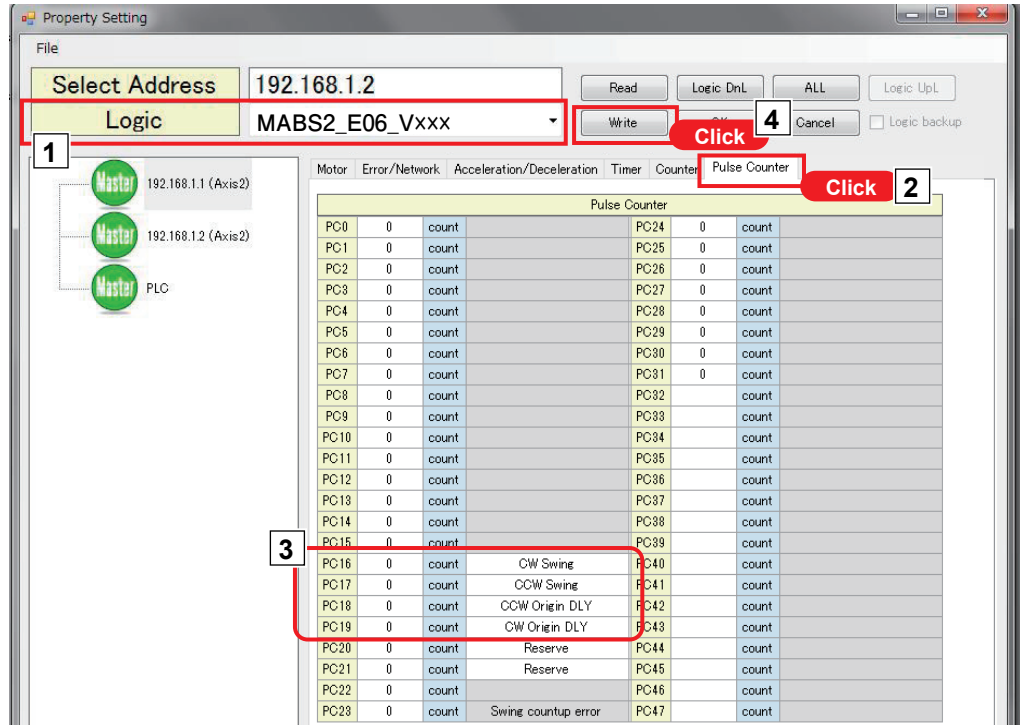

- 1 Select "MABS2_E06_Vxxx" for the logic.
- 2 Select "Pulse counter".
- 3 Set the pulse counter in PC16/PC17/PC18/PC19.

Contact	Description
PC16	Amount of pulses in CW swing movement from the straight state.
PC17	Amount of pulses in CCW swing movement from the straight state.
PC18	Amount of delayed movement when returning to the origin from CCW swing.
PC19	Amount of delayed movement when returning to the origin from CW swing.

※Turning to the straight direction from the swing status does not need to be set.

- 4 Click "Write".

! Perform the above settings for both master and synchronized units.

👉 643 pulses per one rotating.
■ Reference value of CW/CCW swinging angle and value of the pulse.

Angle (°)	Pulse
30	10
45	35
90	105

※ These are reference values.
 Recommend to adjust angle by actual MABS units.

Saving the settings

End of settings.

Click "File-Save", and save the contents that have been specified.

8. IB-E06F-M1 settings

About swing control

Perform swing using the pulse control of IB-E06F-M1 and proximity sensor for origin position.

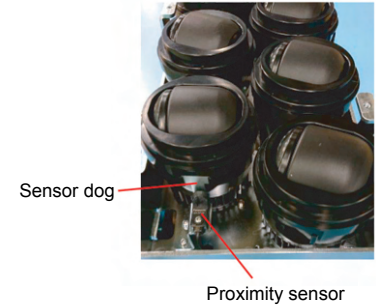

① Origin position (Straight)

Turn the proximity sensor ON (IB-E06F-M1 Sensor A SEN: origin sensor input ON) for straight direction or origin direction.

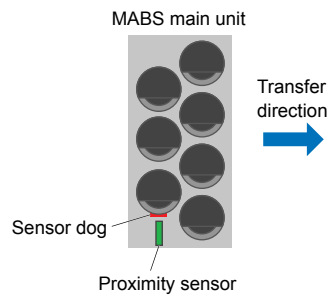

② Swing

Swing will operate for the specified pulses and stop by when pulse counter that is set in IB-E06F-M1 is count up after status of proximity sensor is changed from ON to OFF.

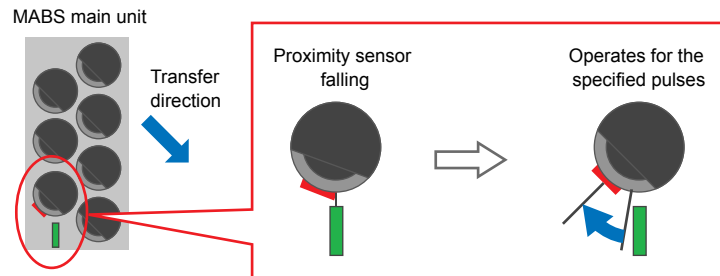

③ Straight (Origin position)

Swing to straight direction(origin position) until proximity sensor is ON. (IB-E06F-M1 SensorA SEN: origin sensor input ON)

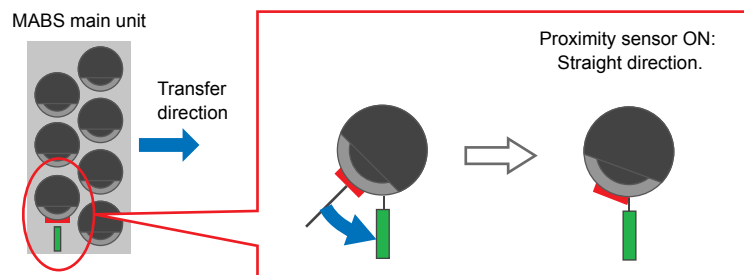

9. Control/Operation

9-1. Before starting control	50
9-2. About Swing control	52
9-3. Basic operation	53
9-4. What to do before operation	56

9. Control/Operation

9-1. Before starting control

Reference of wiring

 **Master unit**
A MABS unit to operate through signal communications with PLCs.

Synchronized unit
A MABS unit to operate by receiving signals from the master unit

Term

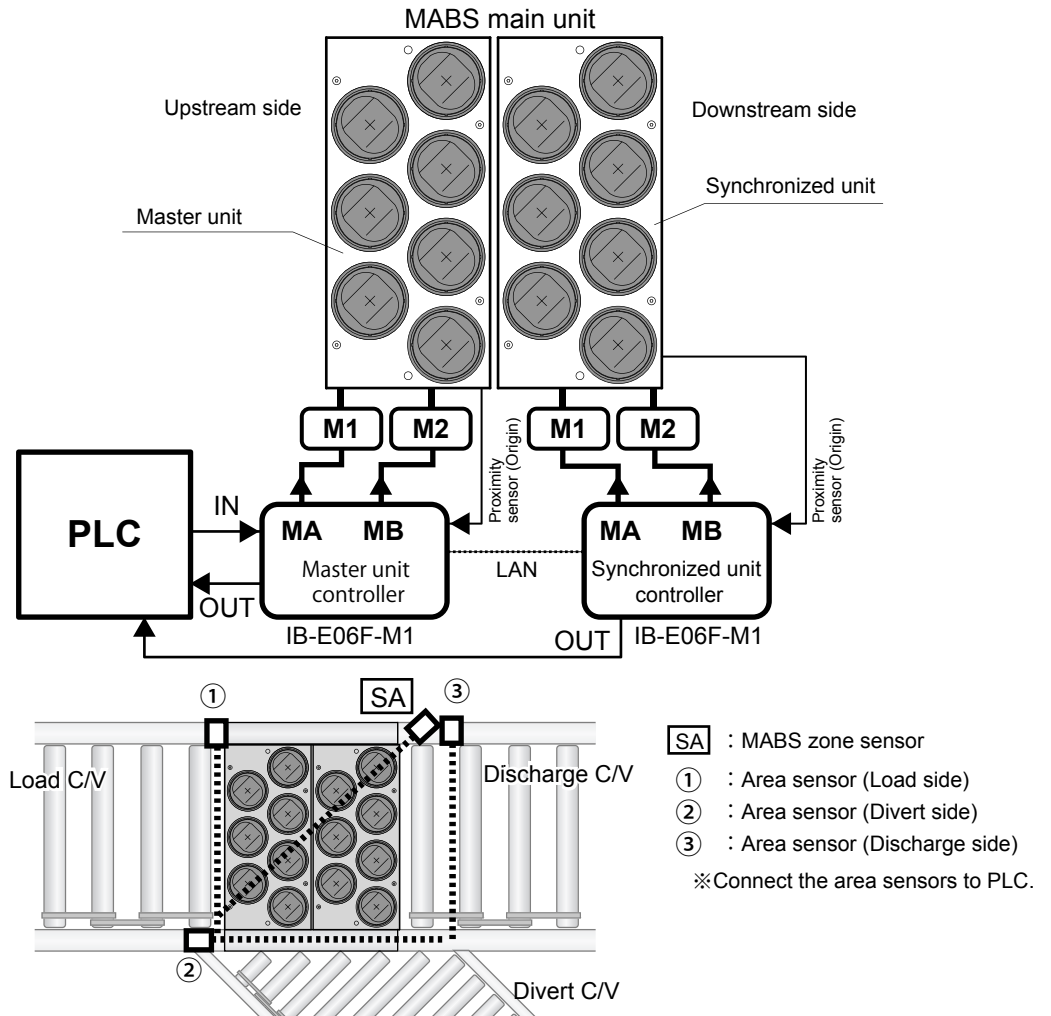

※When each unit set as master unit, each MABS unit can also be operated individually using the signal input/output from PLC.

Wiring Diagram

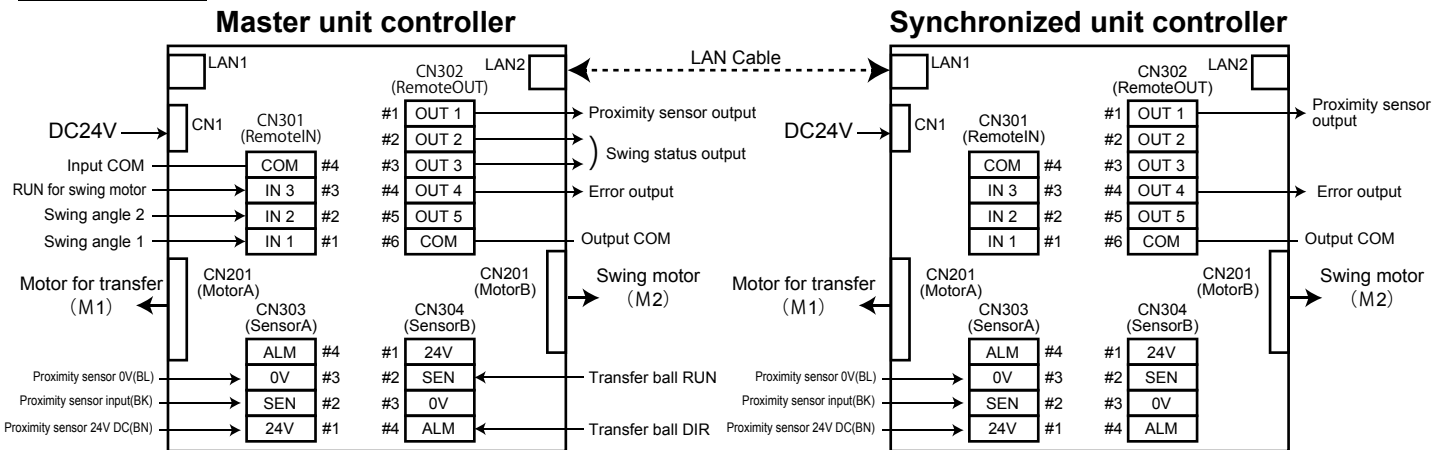

- When using multiple power supply units, 0V of PLC and 0V of controller to be common. Failure to follow this could result in operation failure.
- Make sure to perform wiring so that the most upstream unit is set to be the master unit controller. Also, perform wiring so that units other than the above are set to be the synchronized unit controllers.
- Wire signals from PLC into only master unit.

9. Control/Operation

I/O settings

		I/O	Description	Details
CN201		Motor A	For transfer	M1: Carrying (Labeled on motor cable)
		Motor B	For Swing	M2: Rotating (Labeled on motor cable)
CN303	#2	Sensor A SEN	Proximity sensor input for origin position.	Proximity sensor (Origin position: Prox. Sensor ON for straight direction)
CN304	#2	Sensor B SEN	Transfer ball RUN	Input to run transfer balls (Transfer from upstream to downstream)
	#4	Sensor B ALM	Transfer ball DIR	Input to switch the rotation direction of transfer balls
CN301	#1	RemoteIN1	Specified swing direction	Input to determine the swing direction (Angle is determined by number of motor pulse)
	#2	RemoteIN2		
	#3	RemoteIN3	RUN for swing motor.	Input to start swinging. After inputting the specified swing direction, wait for 20 msec or more until RUN for swing motor is input.
	#4	COM	Input COM	—
CN302	#1	RemoteOUT1	Proximity sensor output	Output proximity sensor signal that connected into own unit. Turn ON to straight direction (Origin position).
	#2	RemoteOUT2	Swing status output	Outputs the current swing status. • When all units have no delay setting: Outputs the swing status after swing is completed in all units. • When at least one unit has the delay setting: Outputs the swing status after own unit completes swing.
	#3	RemoteOUT3		
	#4	RemoteOUT4	Error output	Outputs the error status of the unit. (Outputs only an error of the own unit.)
	#6	COM	Output COM	—

Specified swing direction

Swing	RemoteIN1	RemoteIN2
Divert direction to Straight direction (CW direction)	ON	ON
Divert direction to Straight direction (CCW direction)	OFF	OFF
Straight direction to Divert direction (CW direction)	ON	OFF
Straight direction to Divert direction (CCW direction)	OFF	ON

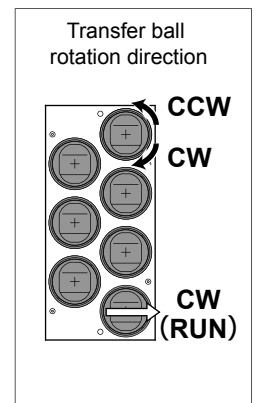

Start Swinging

Swing	RemoteIN3
STOP	OFF
RUN	ON

※Automatically stops when balls have been rotated to the specified angle.

Swing status output

Swing status	RemoteOUT2	RemoteOUT3	Remarks
Straight (origin)	ON	ON	Outputs at the time when balls have been turned to the straight direction
Swing (CW)	ON	OFF	Outputs at the time when swing in CW direction is complete.
Swing (CCW)	OFF	ON	Outputs at the time when swing in CCW direction is complete.
Others	OFF	OFF	During ball swing, when turning on power supply, undetected swing position or occurring software error.

9. Control/Operation

9-2.

About swing control

Perform swing using the pulse control of IB-E06F-M1 and proximity sensor for origin position.

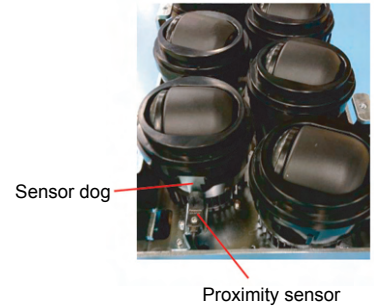

① Origin position (Straight)

Turn the proximity sensor ON (IB-E06F-M1 Sensor A SEN: origin sensor input ON) for straight direction or origin direction.

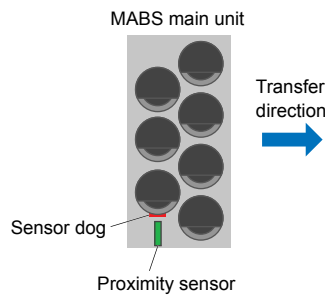

② Swing

Swing will operate for the specified pulses and stop by when pulse counter that is set in IB-E06F-M1 is count up after status of proximity sensor is changed from ON to OFF.

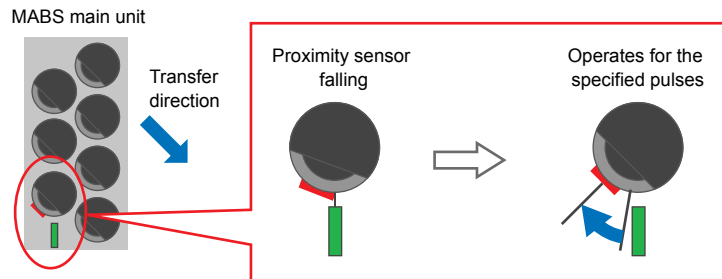

③ Straight (Origin position)

Swing to straight direction(origin position) until proximity sensor is ON. (IB-E06F-M1 SensorA SEN: origin sensor input ON)

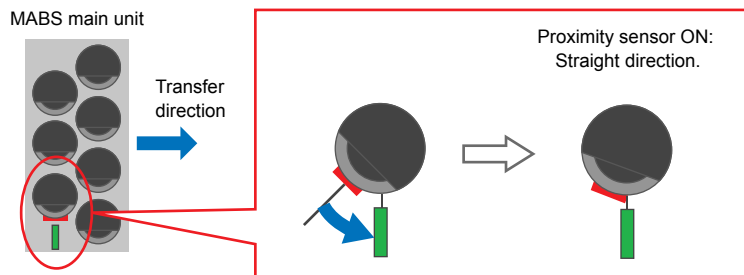

9. Control/Operation

9-3. Basic operation

Initial operation (origin searching)

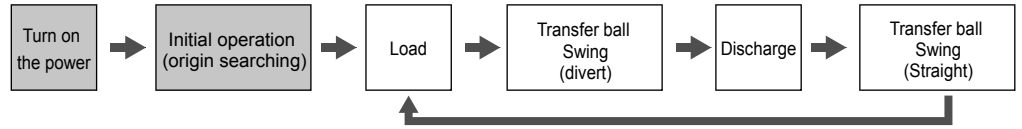

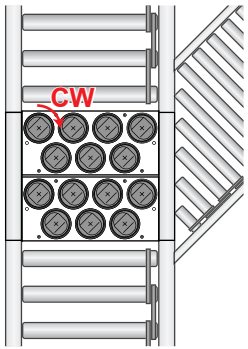
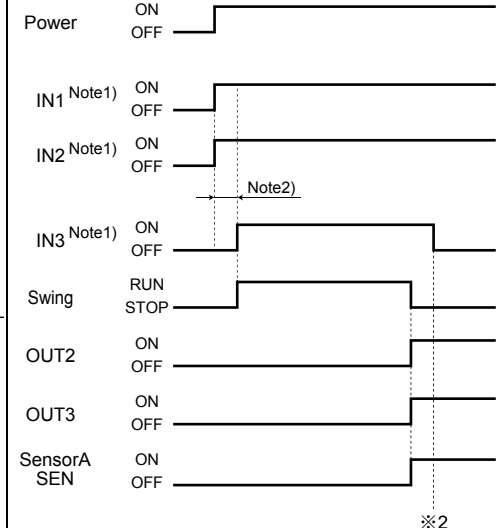
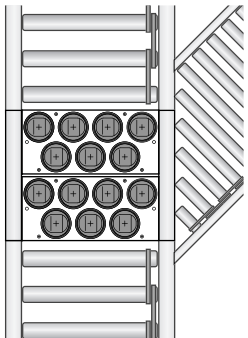
	Operation	IB-E06F-M1 Remote I/O, Sensor	External sensor	Time chart
Initial operation (origin searching)	 <p>Power ON</p> <p>Swing</p>	<p>IN1 ON</p> <p>IN2 ON</p> <p>IN3 ON</p>		 <p>Note1) Signal to IN1 / IN2 for specify swing direction and IN3 for swing must be 50ms or longer. Otherwise transfer ball may behaves unexpectedly.</p> <p>Note2) If the signal input of IN1 and IN2 (specifying the swing direction) is delayed from the signal input of IN3 (swing RUN), an unintended swing operation will occur.</p>
	<p>※1 Stop swinging</p> 	<p>OUT2 ON</p> <p>OUT3 ON</p> <p>IN3 OFF</p>		

※1 Automatically stops when SensorA SEN is ON

※2 After outputting the swinging status, turn IN3 (Swing start) OFF.

9. Control/Operation

Swing from the loading to diverting direction.

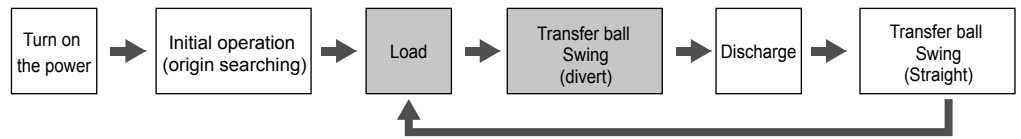

	Operation	IB-E06F-M1 Remote I/O, Sensor	External sensor	Time chart
Load		SensorB SEN ON	Upstream zone sensor ON	<p>Upstream zone sensor: ON (high), OFF (low)</p> <p>SensorB SEN: ON (high), OFF (low)</p> <p>Ball transfer: RUN (high), STOP (low)</p>
Swing to the diverting direction		<p>IN1 ON, IN2 OFF</p> <p>IN3 ON</p>	Area sensor (Load) ON	<p>SensorB SEN: ON (high), OFF (low)</p> <p>Ball transfer: RUN (high), STOP (low)</p> <p>Swing direction IN1 Note1: ON (high), OFF (low)</p> <p>Swing direction IN2 Note1: ON (high), OFF (low)</p> <p>Area sensor (Load): ON (high), OFF (low)</p> <p>IN3 Note1: ON (high), OFF (low)</p> <p>Swing: RUN (high), STOP (low)</p> <p>OUT2: ON (high), OFF (low)</p> <p>OUT3: ON (high), OFF (low)</p> <p>SensorA SEN: ON (high), OFF (low)</p> <p>Pulse count ※2</p>
	※1 Stop swinging	OUT2 ON, OUT3 OFF	IN3 OFF	

※1 After turning SensorA SEN OFF, automatically stops when swing has been executed based on the pulse counter in the CW swing angle settings (PC16).

Note1) Signal to IN1 / IN2 for specify swing direction and IN3 for swing must be 50ms or longer. Otherwise transfer ball may behaves unexpectedly.

Note2) If the signal input of IN1 and IN2 (specifying the swing direction) is delayed from the signal input of IN3 (swing RUN), an unintended swing operation will occur.

※2 After outputting the swinging status, turn IN3 (Swing start) OFF.

9. Control/Operation

Swing from the discharge to diverting direction.

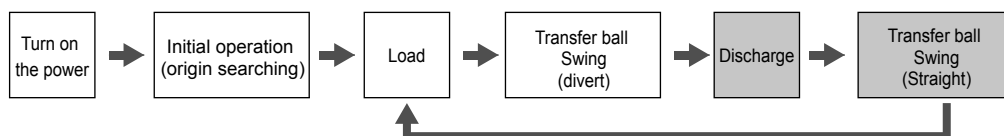

	Operation	IB-E06F-M1 Remote I/O, Sensor	External sensor	Time chart
Discharge		<p>Ball transfer stop</p> <p>SensorB SEN OFF</p>	<p>Area sensor (Divert) ON → OFF</p>	<p>Area sensor (Divert) ON OFF</p> <p>SensorB SEN ON OFF</p> <p>Ball transfer RUN STOP</p>
Swing to the straight direction		<p>Swing</p> <p>IN1 OFF IN2 OFF</p> <p>IN3 ON</p>		<p>IN 1 Note1) ON OFF</p> <p>IN 2 Note1) ON OFF</p> <p>IN3 Note1) ON OFF</p> <p>Swing RUN STOP</p> <p>OUT2 ON OFF</p> <p>OUT3 ON OFF</p> <p>SensorA SEN ON OFF</p> <p style="text-align: right;">※2</p>
	<p>※1 Stop swinging</p>	<p>OUT2 ON OUT3 ON</p> <p>IN3 OFF</p>		<p>Note1) Signal to IN1 / IN2 for specify swing direction and IN3 for swing must be 50ms or longer. Otherwise transfer ball may behaves unexpectedly.</p> <p>Note2) If the signal input of IN1 and IN2 (specifying the swing direction) is delayed from the signal input of IN3 (swing RUN), an unintended swing operation will occur.</p> <p>※2 After outputting the swinging status, turn IN3 (Swing start) OFF.</p>

※1 Automatically stops when SensorA SEN is ON

9. Control/Operation

9-4.

What to do before operation

Start-up inspection

To prevent accidents and/or damage to devices during operation, refer in advance and before operation to the below, and check the safety.

Items to check before turning on the power

Turn off the power of all connected devices, and perform the following inspection, taking necessary measures.



- Turn off the power, wait a sufficient amount of time, and discharge electricity inside the DC power supply equipment.
- Post warning labels so as to prevent unauthorized persons from turning on the power.

Parts to be inspected	Items to be checked	Description of measures
Secured positions of the MABS main unit	Screw looseness	Re-tighten screws
Controller	Damage, deformation	Contact the supplier
	Screw looseness on secured positions	Re-tighten screws
	Mounting failure for controller and connectors	Correctly mount connectors
	Damage to cables/Wiring failure	Perform wiring correctly
MABS main unit	External abnormalities, such as scratches or breakage	Contact the supplier
Transfer ball	Cracks, wear, and/or damage on the surface	Refer to P.64 10-3. Before replacement work
Others	Parts deformation, damage	Contact the supplier
	Cable damage	

Items to check after turning on the power

Manually input the signal to controllers/control devices according to inspection contents.



- After completing measures to prevent clothes from getting caught during transfer, perform inspection.
- Take safety measures, such as getting ready to shut off the power in the event that something should happen.

Parts to be inspected	Items to be checked	Description of measures
Controller	Abnormal temperature rise	Contact the supplier
	Error check with LED display <Normal LED display after the power is turned on> <div style="display: flex; justify-content: space-between; align-items: flex-start;"> <div style="text-align: center;"> STS (Green) ON </div> <div style="text-align: center;"> ERR A OFF </div> </div> <div style="display: flex; justify-content: space-between; align-items: flex-start; margin-top: 5px;"> <div style="text-align: center;"> NS (Green) Blinking [1Hz] </div> <div style="text-align: center;"> ERR B OFF </div> </div> <div style="display: flex; justify-content: space-between; align-items: flex-start; margin-top: 5px;"> <div style="text-align: center;"> MS (Green) ON </div> </div>	Check error contents, and eliminate the causes. ※For details on LED display on controllers and error information, refer to 10-1. Controller' s LED display (P.59).
MABS main unit	Abnormal sound Abnormal temperature rise in the motor (Check with the controller' s ERR LED)	Contact the supplier
Transfer ball	The specified speed cannot be achieved	Check that there is no foreign material stuck and/or no interference with the top cover in the transfer ball section, and eliminate any causes.
Others	Leakage from equipment	Check grounding on equipment, perform grounding

9. Control/Operation

Trial run

Performing the trial run

When the start-up inspection has finished, perform the trial run with careful attention to the following points, and check that operation is correctly performed.



- Prevent other devices around the product from operating.
Other devices incorporated in the system, such as conveyor lines, could create dangerous situations, since totes may start to be transferred from upstream when the trial run is driven.
Check carefully that other conveyors or devices will not operate by trial run.
- Make sure to check that wiring and controller settings have been carried out correctly before the trial run.
- During operation, the transfer speed may not reach the specified value depending on ambient temperature.

10. Maintenance/Inspection

10-1. Controller's LED display	59
10-2. Checking and releasing errors	62
10-3. Before replacement work	64
10-4. Replacement of the transfer ball element set/Grease filling procedure	65

10. Maintenance/Inspection

10-1. Controller's LED display

If errors is occurred, identify the causes of errors by checking controller's LEDs and error signals, and perform recovery work.

IB-E06F-M1

IB-E06F-M1

Position of LED on IB-E06F-M1

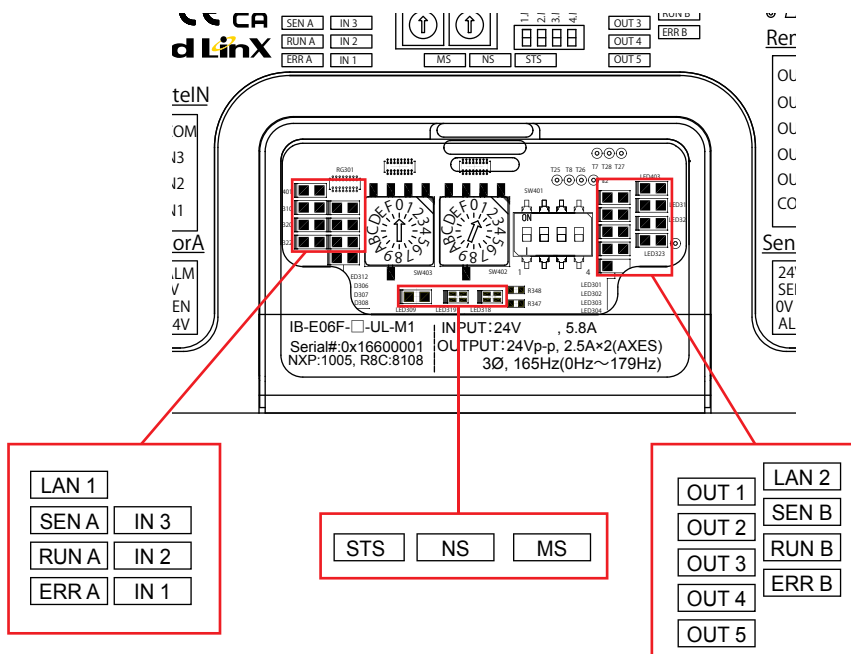

Safety precautions

Advance preparation

Product check

Structures

Installation/Wiring

IB-E06F-M1 settings

Control/Operation

Maintenance/Inspection

Troubleshooting

Appendix

10. Maintenance/Inspection

● LED indication

LED type	LED indication pattern	Description
MS LED MS	OFF	Power OFF on Network PCB (* 1)
	ON(Green)	Normal startup
	ON(Green) ⇄Blinking(1Hz)(RED)	Device (IP address, etc.) has not been specified
	Blinking(1Hz)(RED)	Communication error (LAN1 or LAN2 port)
	ON(RED)	Communication error (LAN1 and LAN2 ports)
	Blinking(1Hz) (Green)⇄ Blinking(1Hz) (RED)	At the time of startup settings (when the power is turned ON)
NS LED NS	OFF	No communication
	Blinking(1Hz) (Green)	Normal startup (IP address obtained normally)
	ON(Green)	I/O connection has been established
	Blinking(1Hz) (RED)	I/O connection timeout
	ON (RED)	IP address overlap
	Blinking(1Hz) (Green) ⇄Blinking(1Hz) (RED)	At the time of startup settings (when the power is turned ON)
STS LED STS	ON(Green)	Power ON on Network PCB
	Blinking(6Hz) (Green)	Low voltage error
	Blinking(1Hz) (Green)	During firmware is updating.
	OFF	Power OFF on Network PCB
LAN LED LAN 1 LAN 2	Blinking (Green)	During communication
	OFF	No communication
Sensor LED SENA	ON(Green)	In case, input of proximity sensor for origin position is ON
	OFF	In case, input of proximity sensor for origin position is OFF
Sensor LED SEN B	ON(Green)	In case, run signal for transfer ball is input.
	OFF	In case, run signal for transfer ball is not input.
Remote IN LED IN 1 IN 2 IN 3	ON(Green)	With remote input
	OFF	Without remote input
	OFF	Without remote input
Remote OUT LED OUT 1 OUT 2 OUT 3 OUT 4 OUT 5	ON(Green)	With remote output
	OFF	Without remote output
RUN LED RUN A RUN B	● Refer to Error details (P.61)	
ERR LED ERR A ERR B		

(※1) MS LED is also OFF when the rotary switch (SW402, SW403) is "00".

10. Maintenance/Inspection

● Error details

The table below described the LED indications, occurrence conditions, error release conditions and MDR status when an error occurs.

Use iCEP Lite to check the type of error, and release errors manually.

Errors will be also reset when the power is OFF.

Refer to (10-2. Checking and releasing errors)

Type of error	Priority (※1)	RUN LED	ERR LED	Statuses/Error occurrence conditions	Error release conditions (※2)	Type of error release	MDR
		OFF	OFF	When the motor stops (No error)			Stop
		Blinking (1Hz)	OFF	When the MDR is running in the CW direction			Run
		ON	OFF	When the MDR is running in the CCW direction			Run
Low voltage error	1	STS LED Blinking(6Hz)		Power supply voltage is less than 20 V	Supply more than 20V DC or more	Automatic	Stop
Fuse blown error	2	OFF	Blinking (6Hz)	Controller fuse meltdown	Cannot be released (※3)	—	Stop
Unconnected motor error	3	OFF	Blinking (1Hz)	Motor cable connector disconnected	Turn off the power, and connect the connector	Automatic/ Manual	Stop
Lock error	4	ON	Blinking (1Hz)	Motor is locked. (No feedback from motor)	Automatic release: Pulse change Manual release: Release command from the upper level	Automatic/ Manual	Stop
Controller thermal error	5	OFF	ON	PCB temperature has exceeded the threshold value for one second	Decreased controller temperature to the threshold value or less	Automatic/ Manual	Stop
Motor thermal error	6	OFF	ON	Motor temperature has exceeded the threshold value for one second	Decreased motor temperature to the threshold value or less	Automatic/ Manual	Stop
Back EMF error	7	ON	Blinking (twice at 6Hz with 1.7S cycle)	Supply voltage more than 40V DC for 2 seconds or supply voltage more than 60V DC for 0.1 seconds.	Supply voltage 40V DC or less	Manual	Stop
Soft error	8	Blinking alternately (6Hz)	Blinking alternately (6Hz)	Swing for 1000 pulses without changing status of proximity sensor.	Cannot be released (※4)	—	Stop

(※1) If multiple errors occur at the same time, the LED indication will be selected based on the highest priority error.

In addition, when releasing an error during occurring multiple errors, lower priority errors than the released error will also be released.

Note that if any factors for lower priority errors remain after error release, an error will occur again.

(※2) It is applicable to use iCEP Lite for manual error release.

(※3) There is no error release procedure for the fuse blown error. Replace IB-E06F-M1.

(※4) Proximity sensor may be damaged or disconnected.

10. Maintenance/Inspection

10-2. Checking and releasing errors

Checking error statuses

Use iCEP Lite to check error statuses in IB-E06F-M1, and release errors manually.

- 1 Select "Error information" from "Dialog" in the menu.

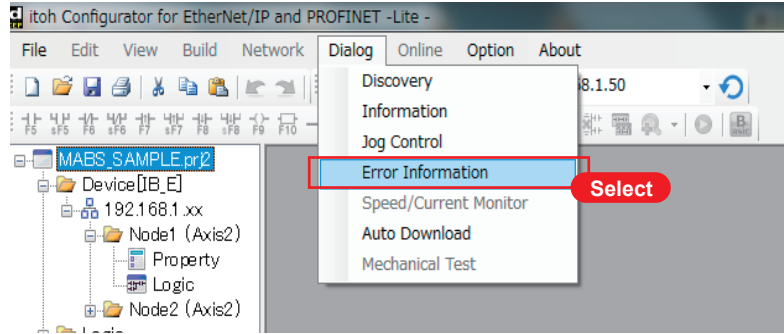

- 2 Select the IP address for the PC, and click "OK".

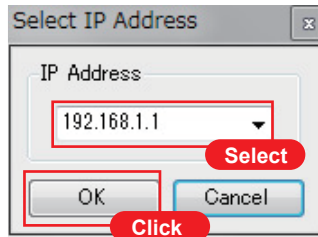

- 3 The following window is displayed. The current error statuses on the IB-E06F-M1 are displayed on this window.

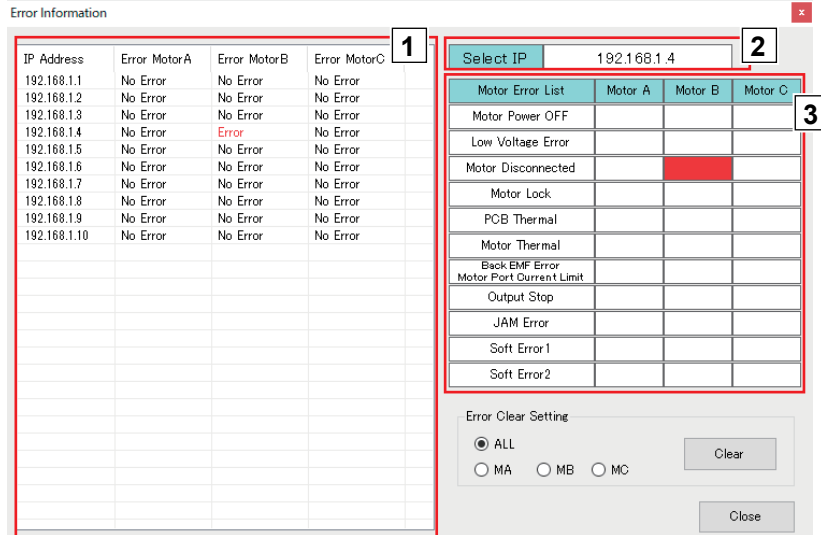

- 1 Error information window
There are displayed error status for all connected controllers. "No Error" is displayed for the motor where no error occurs, "Error" for the motor where an error occurs, and "-" when no motor is connected.
- 2 The IP address for the selected controller is displayed
To specify other controllers, click an optional IP address on 1 to switch to the controller with the selected IP address.
- 3 The error status for the controller selected in 2 is displayed.
The error status for the selected controller is displayed in the motor error list. Error items for motors where errors occur will turn red.

10. Maintenance/Inspection

Releasing the error manually

Release the error in the error release settings.



■ Soft error 1 cannot be released.
(The error occurs when proximity sensor has not been detected (refer to P.61))

- 1 When specifying the IP address for the controller of which the error is to be released, the selected IP address is displayed in Select IP.
- 2 Select the motor of which the error is to be released in the error release settings, and click "Clear".

Error Information

IP Address	Error MotorA	Error MotorB	Error MotorC
192.168.1.1	No Error	No Error	No Error
192.168.1.2	No Error	No Error	No Error
192.168.1.3	No Error	No Error	No Error
192.168.1.4	No Error	Error	No Error
192.168.1.5	No Error	No Error	No Error
192.168.1.6	No Error	No Error	No Error
192.168.1.7	No Error	No Error	No Error
192.168.1.8	No Error	No Error	No Error
192.168.1.9	No Error	No Error	No Error
192.168.1.10	No Error	No Error	No Error

Select IP: 192.168.1.4

Motor Error List	Motor A	Motor B	Motor C
Motor Power OFF			
Low Voltage Error			
Motor Disconnected			
Motor Lock			
PCB Thermal			
Motor Thermal			
Back EMF Error			
Motor Port Current Limit			
Output Stop			
JAM Error			
Soft Error 1			
Soft Error 2			

Error Clear Setting:
 ALL
 MA MB MC

Clear

Close

10-3. Before replacement work

Conducts an appropriate measure if any abnormalities are found, such as parts damaged.

Maintenance parts



■ Do not store the transfer ball element in places subject to high temperature, high humidity, and/or direct sunlight. Failure to follow this could result in its lifetime to be significantly shortened.

Replacement parts

When removing the top cover

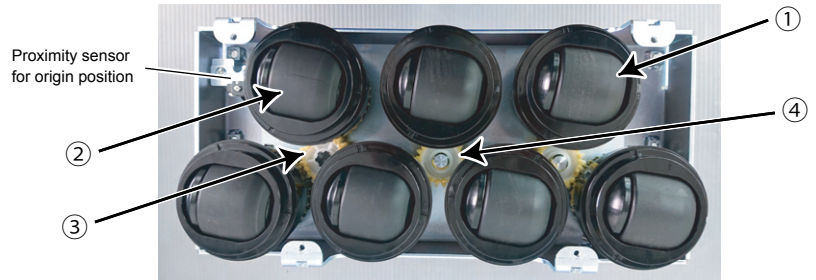

When removing the bottom cover

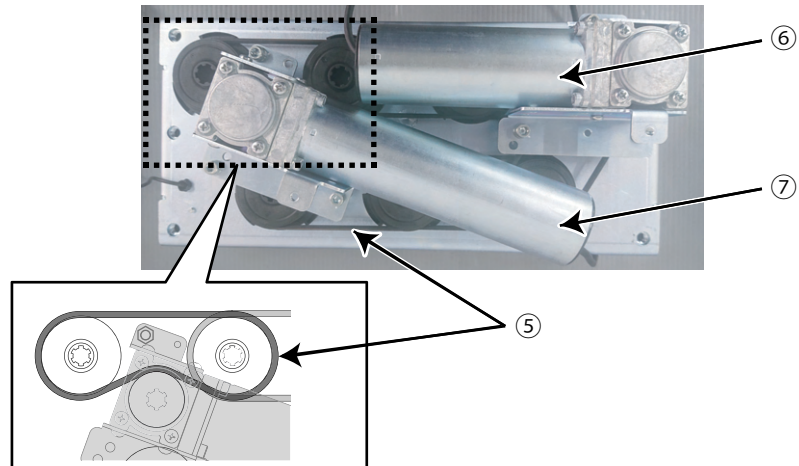

10. Maintenance/Inspection

① Transfer ball element set

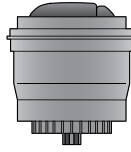

② Transfer ball element set (With sensor dog)

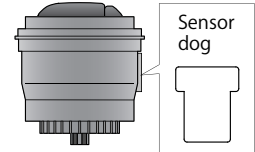

③ Gear A (Spline)

It is for ball swing.



④ Gear B

It is for ball swing.

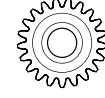

⑤ Link belt 2PJ376

It is for ball rotation.

⑥ Transfer motor

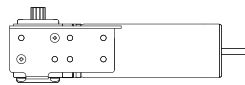

⑦ Swing motor



⑧ Controller

Others

- Link belt replacement jig (Model : MT-BR01)
※Necessary for mounting the link belt.
- Grease : SUMICO Lubricant : Sumitec 305

Replacement parts model number and required quantity per 1 unit

	Model	QTY	Required quantity per 1 unit for each size				
			400	500	600	700	800
① Transfer ball element set	MABS-BE03	1	6	8	10	12	14
② Transfer ball element set (With sensor dog)	MABS-BE04	1	1				
③ Gear A (Spline)	MABS-GRS80 ※1	1 set	1				
④ Gear B			2	3	4	5	6
⑤ Link belt	2PJ376	1	6	8	10	12	14
⑥ Transfer motor	RGM520KT-1130-D024-OS MABS2Transfer	1	1				
⑦ Swing motor	RGM520KT-160-D024-OS MABS2Swing	1	1				
⑧ Controller	IB-E06F-□※2 -UL-M1	1	1				

※1 There are included 1pce of Gear A and 6pcs of Gear B.

※2 □:Specify the N=NPN/P=PNP type based on the sensor signal input type.

About replacement

Please contact us for replacement of Gear A/B, link belt, and motors for transfer and swing.

10. Maintenance/Inspection

10-4.
Replacement of the transfer ball element set/ Grease filling procedure

Replace a ball element which has the following symptoms.

- The actual speed is slower than a setting.
- There is occurred an abrasion on ball.
(Groove depth is 1.5mm as a guide.)

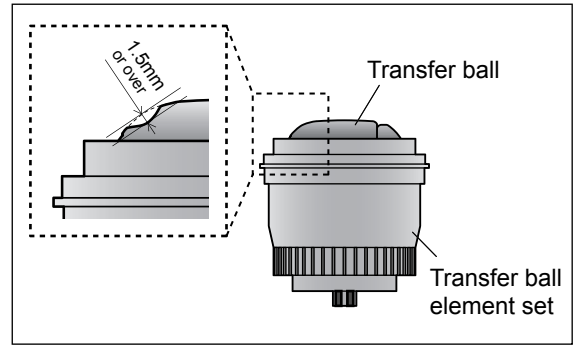

Before replacement

Tools to be used

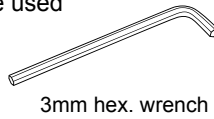

3mm hex. wrench



- Shut down the power, leave for three minutes or more, and discharge electricity inside the DC power supply equipment.
- Wear protective equipment, such as gloves.

Replacement procedures

Replacement of the transfer ball element set

Removing the top cover

- 1** Remove all ultra-low head bolts (M5), and remove the top cover.

Bolt for mounting a top cover Top cover

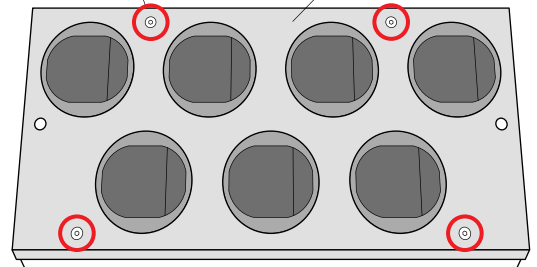

Replacing the transfer ball element set

- 1** Remove the transfer ball element set to be replaced from the MABS main unit.



- Slowly pull directly upward. Failure to follow this could result in damage to parts.

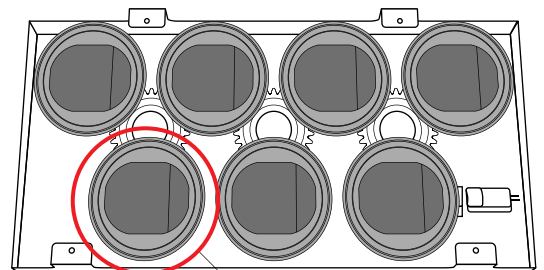

Transfer ball element set

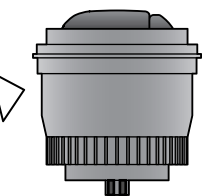
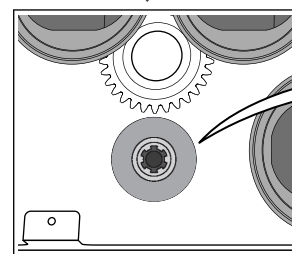

Transfer ball element set

10. Maintenance/Inspection

2 Mount a new transfer ball element set according to the following procedure.

2-1 Divide the transfer ball element set into each part, and mount the gear cup **1** to the main unit. *Note 1)*
(Refer to the figure on the right)

2-2 Align part A of SUS cup **2** with part B of the main unit when mounting.

2-3 Mount the transfer balls **3**.
Note 2) Align the notch shape of the gear cup **1** with the shaft shape of the transfer ball **3**.

Note 3) Mount the transfer ball **3** in the same direction as the surrounding transfer balls.

2-4 Mount the gear cup cover **4**.

2-5 After replacement, check the following items.

- Check if the replaced ball is aligned with the angle and mounting direction of surrounding ball.
- Check if the replaced ball is aligned with the height of surrounding ball.
(The gear has been engaged.)

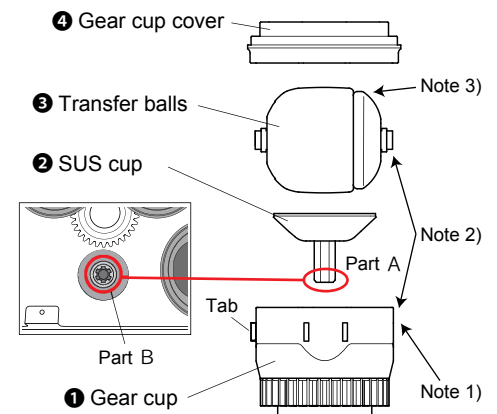

Note 1)

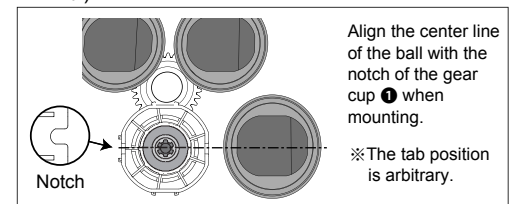

Note 2)

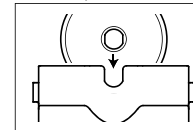

Note 3)

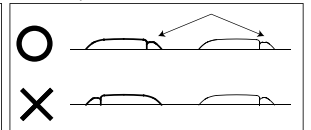

When installing the MABS-BE04 unit, turn the ball in the straight direction, and mount the gear cup **1** to the main unit by aligning the proximity sensor (for origin position) with the center of the sensor dog. *Note 4)*

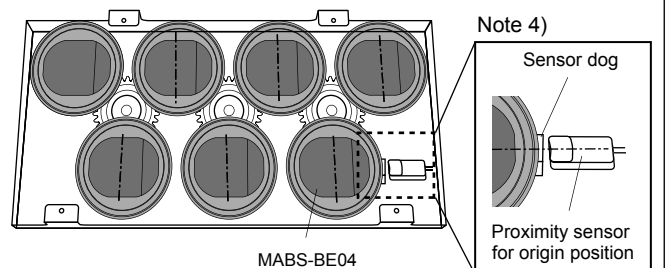

Mounting the top cover

1 Use the ultra-low head bolts (M5), and mount the top cover.



- Recommended tightening torque 3.2N·m
- After mounting the top cover, press each transfer ball using your fingers, and check that the springs function properly by moving them up and down.
- Check that parts including previously removed bolts have been securely mounted again, and all parts have been mounted.

Bolt for mounting a top cover Top cover

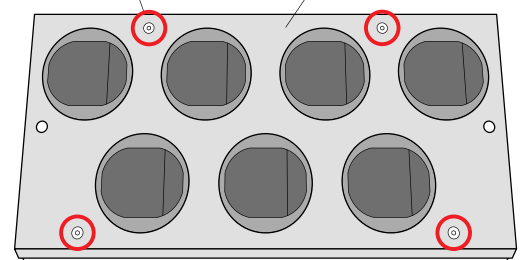

10. Maintenance/Inspection

Grease filling

Fill grease once a year from the original date of installation.

※For the date of installation, check the date of installation label.

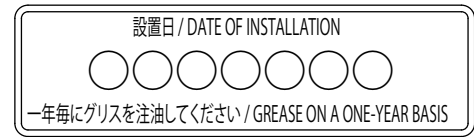

Grease filling procedure

Removing the top cover

- 1 Remove all ultra-low head bolts (M5), and remove the top cover.

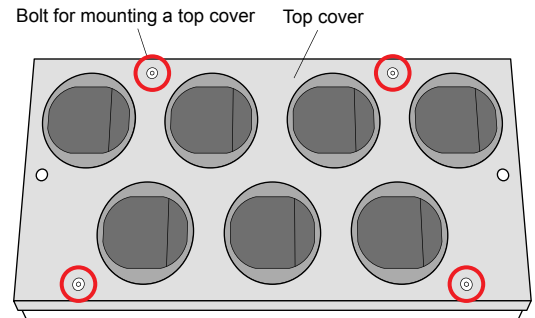

Filling grease

- 1 Apply 1 to 2 g of grease to each gear tooth.

If foreign materials have entered the grease, or the grease is otherwise significantly dirty, remove old grease, and apply new grease, or contact the supplier.

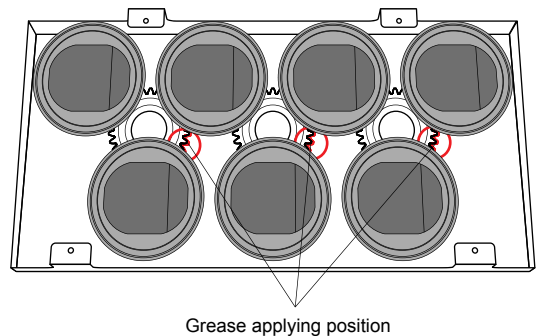

Mounting the top cover

- 1 Use the ultra-low head bolts (M5), and mount the top cover.

- Recommended tightening torque 3.2N·m
- After mounting the top cover, press each transfer ball using your fingers, and check that the springs function properly by moving them up and down.
- Check that parts including previously removed bolts have been securely mounted again, and all parts have been mounted.

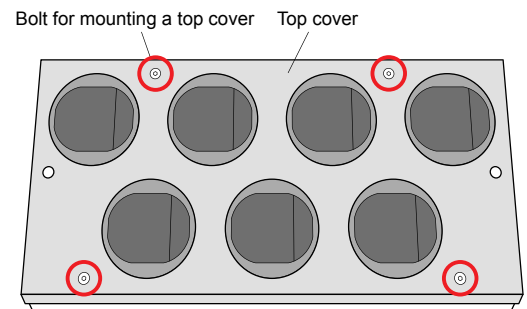

11. Troubleshooting

11. Troubleshooting

For troubleshooting, check the contents described in this section before contacting supplier and/or asking to repair.

Symptoms

MABS does not operate

Items to be checked	Countermeasures	References
Is PWR LED (Green) for each controller ON? Or, has 24V DC been supplied in the power connector of controllers?	Supply 24V DC.	7. Installation/ Wiring (⇒P.34)
Is ERR LED (Red) for each controller blinking, or is it ON and is there an error output?	Remove the cause of error, and release the error.	10. Maintenance and inspection (⇒P.60)
Has each connector been connected correctly? Has wiring been performed properly?	Check and correct wiring.	7. Installation/ Wiring (⇒P.34)
Check if NPN/PNP in/output wiring is correct between controller and PLC.	Check the signal type, NPN or PNP, wires it correctly.	6. Product check (⇒P.20)
Is the voltage for controller's control signals common to that for the control signals of PLC, etc.?	Make 0V of input voltage of the control signal from controller and 0V of power supply voltage common.	7. Installation/ Wiring (⇒P.34)
Is the voltage to be input/output to Remote I/O common to the control device voltage?	Make 0V of input/output voltage on Remote I/O and 0V of control device's voltage common.	7. Installation/ Wiring (⇒P.34)

The MABS speed/swing angle has not been changed or is different from that for other units

Items to be checked	Countermeasures	References
Have the settings been written for both master and synchronized units? Also, was the write button pressed when setting?	Write the settings for both master and synchronized units.	8. IB-E06F-M1 settings (⇒P.46, P.47)

11. Troubleshooting

Symptoms

When loading/discharging, totes get stuck, or cannot be transferred

Items to be checked	Countermeasures	References
Have M1: Transfer motor and M2: Swing motor been connected correctly?	Shut down the controller's power, and connect motors correctly.	7. Installation/Wiring (⇒P.33)
Have proximity sensor for origin position type in the MABS main unit and controller type (NPN input / PNP input) been matched? ※Check the model of MABS main unit and controllers.	Match the proximity sensor type in the MABS main unit and controller type (NPN input / PNP input).	5. Product check (⇒P.20) 6. Structures (⇒P.22)
Is transfer surface level of infeed/discharge conveyor and MABS unit same?	Align transfer surface level of the infeed/discharge conveyor and MABS unit.	7. Installation/Wiring (⇒P.31)
Have the transfer balls become worn?	Replace the transfer ball element set.	10. Maintenance and inspection (⇒P.60)
Is the swing angle when diverting correct?	Adjust the swing angle.	8. IB-E06F-M1 settings (⇒P.47)

The transfer direction is different from the setting

Items to be checked	Countermeasures	References
Has the MABS main unit been installed in the correct direction?	Align the installation direction of the MABS main unit (turn the row of less transfer balls to the upstream side).	7. Installation/Wiring (⇒P.31)

Appendix

Appendix

Appendix 1.
Product specifications

MABS main unit specifications

MABS main unit specifications

Size		400	500	600	700	800
MABS main unit	Total length (L)	186mm				
	Total width (W)	398mm	498mm	598mm	698mm	798mm
	Height (H)	175mm				
	Weight	14.5kg	15.4kg	16.3kg	17.2kg	18.0kg
Maximum load weight that can be transferred ※1		30kg				
Minimum size that can be transferred (mm) ※2		150L × 100W				
Maximum size that can be transferred (mm) ※2		650L × 300W	650L × 400W	650L × 500W	650L × 600W	650L × 700W
Speed	Ball rotation speed	30 ~ 60m/min ※3				
Material	Frame	Copper, Electro - galvanizing				
	Transfer section (transfer ball)	Urethane (P-4797) Black				
	Top cover	Stainless steel				
Proximity sensor for origin position	NPN output	GX-H12A				
	PNP output	GX-H12A-P				
Installation environment	Ambient temperature	0 to 40°C (no freezing)				
	Ambient humidity	90%RH or less (no condensation)				
	Altitude	1,000m or less				
	Atmosphere	No corrosive gas				
	Vibration	0.5G or less				
	Installation location	Indoor				
	Mounting surface tilt (inclination)	0.5% or less				
	Degree of contamination	2 (according to the definition of IEC60664-1)				
※4 Swing angle and time	Angle (degree)	30	45	60	90	
	Time (msec)	150	160	190	250	

- ※1 Values of the maximum load weight are reference only, since they may change depending on totes conditions. Offset load and depending on the bottom shape of totes, they may not be transferred normally, even if they are within the above size range.
- ※2 When transferring by setting two units with ball rotation speed of 60 m/min. and diverting angle of 45 degrees. The size that can be transferred depends on the speed, load weight, material, bottom surface, shape of totes, ambient temperature, and/or transfer conditions.
- ※3 Values indicate the speed that can be specified when totes are not placed. The speed can be specified up to 90 m/min., but transfer conditions depend on the speed, load weight, material, bottom surface, shape of totes, and/or ambient temperature. Make sure to check transfer availability in advance.
- ※4 Indicates the value when totes are not placed.

 Values described above may differ from the actual transfer speed depending on the weight, material, bottom surface, and/or shape of totes, as well as ambient temperature.

 During operation, the rising time to the setting speed may vary depending on ambient temperature. Perform running operation thoroughly.

Product label

MULTI ANGLE BALL SORTER

① MABS2-K90-400A04-C12-EN

② RATED INPUT: DC24V / 9.8A

③ RATED POWER: 112W

④ PAYLOAD: max 30 kg

⑤ SERIAL No: 20 04 01 001

⑥ MFG. YEAR: 2020

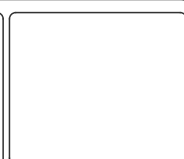
 ITOH DENKI CO.,LTD
 MADE IN JAPAN

- ① Product model
- ② Input voltage/Rated current
- ③ Rated output
- ④ Maximum load weight that can be transferred
- ⑤ Serial No.
- ⑥ Year of manufacture

Date of installation label

設置日 / DATE OF INSTALLATION

○ ○ ○ ○ ○ ○ ○ ○

一年毎にグリスを注油してください / GREASE ON A ONE-YEAR BASIS

Safety precautions
Advance preparation
Product check
Structures
Installation/Wiring
IB-E06F-M1 settings
Control/Operation
Maintenance/Inspection
Troubleshooting
Appendix

Appendix

Appendix 1.
Product specifications

Controller specifications

Model		IB-E06F-□-UL-M1 (□=N : NPN, P : PNP)
Power supply voltage		24V DC±10%
Rated voltage		24V DC
Static current		0.2A
Starting current		7 A / Motor
Peak current		30 A (1 ms or less)
Wire diameter Applicable wires to connectors included as standard	Power connector (CN1)	1.25 ~ 2.5mm ² (AWG : 16 ~ 12)
	Control connector (CN2)	0.08 ~ 0.5mm ² (AWG : 28 ~ 20)
Protective functions		Incorrect wiring protection Built-in 15 A fuse
Protective functions		Controller unit : 95°C Motor : 105°C
Operating environment	Ambient temperature	0 to 40°C (no freezing)
	Ambient humidity	90%RH or less (no condensation)
	Atmosphere	No corrosive gas
	Vibration	1.0 G or less
	Installation location	Indoor
Time from RUN signal input to motor starting		15 msec or less

Appendix

Appendix 2.
Options

MDR extension cables
(Option)

■ 12P extension cable : MABS [M1, M2] — IB-E06F-M1 [MA, MB]

Model	Extension cable length
ACE-CBM-G0600	L= 600mm
ACE-CBM-G1200	L=1200mm
ACE-CBM-G2000	L=2000mm

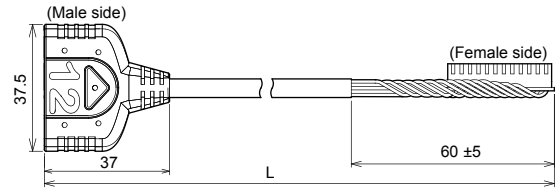

Stay (option)
Product designation

Indicates the product for one stay. Two stays are necessary for one unit.

MABS - FST 400 B



- ② Mounting
A: For M6, top side installation
B: For M8, bottom side installation
- ① Dimension between frames (W)

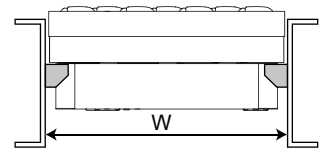

For M6

This is used when securing the MABS main unit on the top side.

※Customers must remove the top cover of the MABS main unit, and fasten the main unit and stay.

Dimension between frames/W (mm)	A
For W=400 to 415	(W-400)+2+30
For W=500 to 515	(W-500)+2+30
For W=600 to 615	(W-600)+2+30
For W=700 to 715	(W-700)+2+30
For W=800 to 815	(W-800)+2+30

※W indicates the dimension between frames on which this part is mounted.

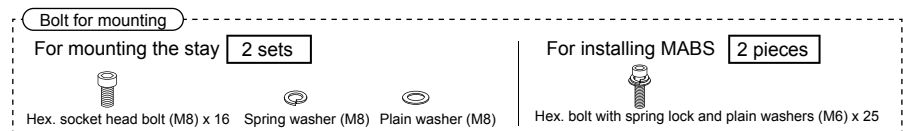
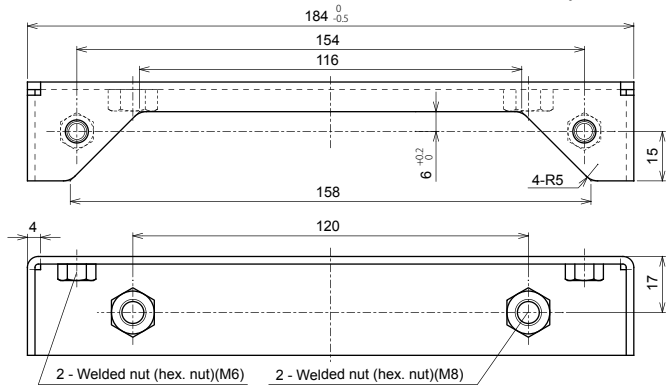
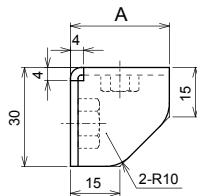

For M8

This is used when securing the MABS main unit on the bottom side.

Dimension between frames/W (mm)	A
For W=400 to 415	(W-400)+2+30
For W=500 to 515	(W-500)+2+30
For W=600 to 615	(W-600)+2+30
For W=700 to 715	(W-700)+2+30
For W=800 to 815	(W-800)+2+30

※W indicates the dimension between frames on which this part is mounted.

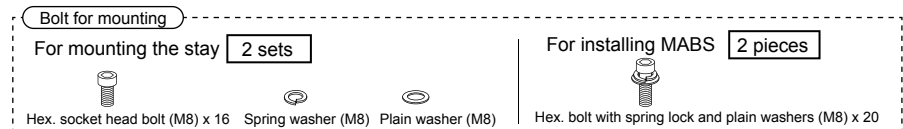
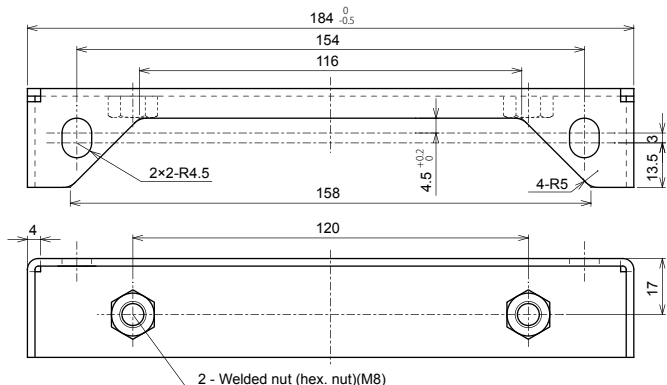
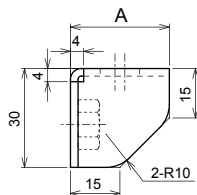

Appendix

Appendix 3.
Residual risk list/MAP

Residual risk list

No.	Operation stage	Work	Qualifications/ education required for work	Locations on machine	Seriousness of harm	Remaining risk factors	Examples of assumed measures	Measures that have been taken independently	Reference page
1	Installation	Unpack/ Carry	Having carefully read the user manual, and having full knowledge of all the contents	Metal parts on the product	CAUTION	Hands may get injured	When working, wear protective equipment, such as gloves	Described in the instruction manual	9
2	Installation	Carry		No particular location	CAUTION	Carrying the heavy load alone may result in damage to the main machine unit, and/or injury to the body	When carrying, have more than one person hold and support the bottom	Described in the instruction manual	9
3	Installation	Carry/ Install		No particular location	CAUTION	Dropping the product may result in damage to the product main unit, and/or injury to the body	Check safety of installation location in advance, and wear protective equipment, such as protective glasses, footwear, and/or gloves, when working	Described in the instruction manual	8,9
4	Installation	Installation		Bottom of the product	CAUTION	Fingers may get stuck when securing the product main unit on the stay, and the user may be injured	When putting the product main unit on the stay, hold the specified position of the main unit, and prevent fingers from getting stuck	Described in the instruction manual	31
5	Operation	Trial run		No particular location	CAUTION	During trial run, totes may be unexpectedly transferred to the product	Stop the surrounding conveyor operation before starting operation	Described in the instruction manual	57
6	Operation	All during operation		Top panel of the product	CAUTION	Workers may step on the product and lose their footing Or fall down due to movement of the product	Keep workers informed thoroughly about the prohibition of stepping on the product.	Described in the instruction manual	8
7	Operation	All during operation		No particular location	CAUTION	If problems occur, totes may collide with each other, and pop out of the equipment	For example, mount guide rails on the conveyor frames, and prevent totes from popping.	Described in the instruction manual	10
8	During maintenance/ inspection	All during maintenance/ inspection		Power supply part to the product (controller)	WARNING	Persons turning on the power without notice may result in unexpected operation of the product, and/or injury of workers	Post warning labels so as to prevent unauthorized persons from turning on the power	Described in the instruction manual	11
9	During maintenance/ inspection	All during maintenance/ inspection		• Metal parts on the product • Gear section	CAUTION	Hands and/or fingers may be injured by metal parts, or the user may be injured if hands and/or fingers get stuck in the gear or belt section	<ul style="list-style-type: none"> Wear protective equipment, such as gloves Do not put hands close to rotating parts. When you need to get your hands close to rotating parts during operation, take off gloves 	Described in the instruction manual	8,11

Seriousness of harm

WARNING: Indicates that there is a possibility that severe injury or even death may result if protective measures have not been taken

CAUTION: Indicates that there is a possibility that minor injury may result if protective measures have not been taken

Residual risk MAP

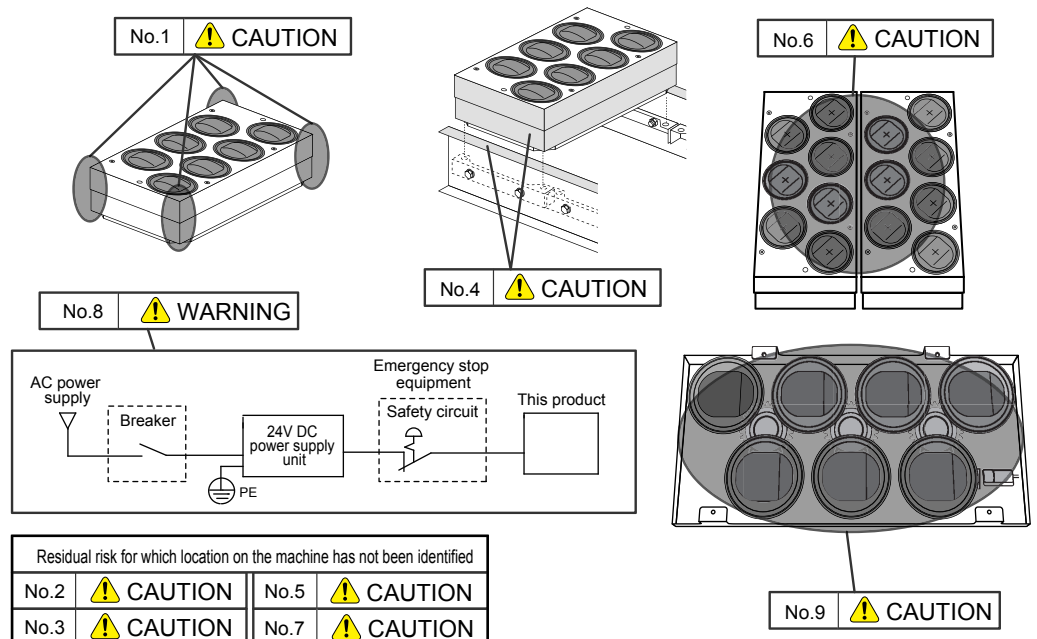

Technology for tomorrow



ITOH DENKI CO.,LTD.

■ **Southeast Asia, South Asia, Oceania:**

ITOH DENKI CO., LTD. (Headquarters)

1146-2, Asazuma-Cho, Kasai, Hyogo 679-0105
Phone: +81 (0)790 47 0955 Fax: +81 (0)790 47 1325
www.itohdenki.co.jp

■ **Europe, Middle East, Africa:**

ITOH DENKI EUROPE SAS

Phone: +33 (0)4 50 03 09 99 Fax: +33 (0)4 50 03 07 60
www.itoh-denki.com

■ **North & South America:**

ITOH DENKI USA, INC

Phone: +1 570 820 8811 Fax: +1 570 820 8838
www.itohdenki.com

■ **Hong Kong, Korea, Taiwan:**

ITOH DENKI ASIA LIMITED

Phone: +852 2427 2576 Fax: +852 2427 2203

■ **China:**

ITOH DENKI SHANGHAI CO., LTD.

Phone: +86 21 6341 0181 Fax: +86 21 6341 0180
www.itohdenki.com.cn

<https://www.itohdenki.co.jp>

Specifications or appearance of product are subject to change without prior notice.

Ver.2.0